

Security Command[®]
EXECUTIVE SERIES

XR500

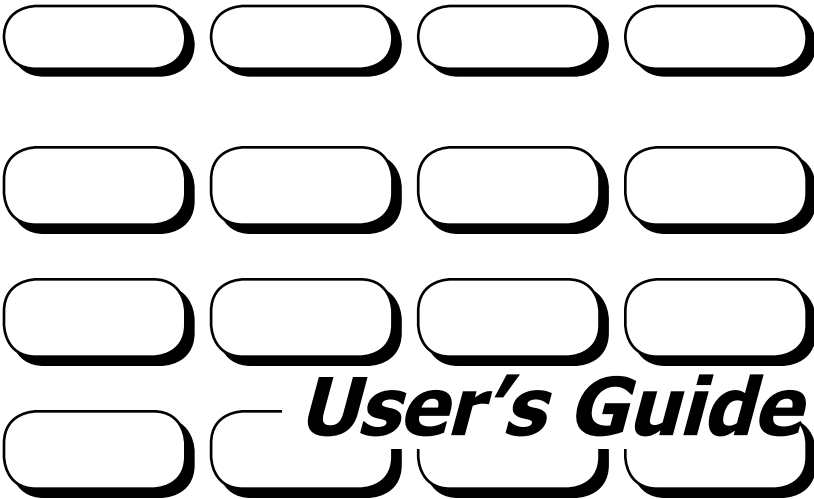

Silencing an Alarm

1. While the alarm bell or siren is sounding, press the COMMAND key until MENU? NO YES appears. Press the select key under YES. Enter your user code. Press the COMMAND key until ALARM SILENCE appears. Press any top row select key. The system silences the alarm bell or siren.
2. If your system is programmed to send an Abort (alarm cancel) report to the central station, the keypad displays ALARM CANCELLED.

Copyright© 2003 Digital Monitoring Products, Inc.

Information furnished by DMP is believed to be accurate and reliable.

This information is subject to change without notice.

Security Command User's Guide for XR500 Command Processor™ Panels Table of Contents

| <i>Section</i> | <i>Page</i> | <i>Section</i> | <i>Page</i> |
|---|-------------|--|-------------|
| Introduction | | Using the Keypad | 4 |
| About Your Security System | 1 | Keypad Displays Current Programming..... | 4 |
| Parts of the System | 1 | Multiple Displays Containing Programming | 4 |
| Security Command Keypad..... | 1 | Asterisks in Programming..... | 4 |
| Keypad User Menu | 1 | User Options..... | 5 |
| A Note About False Alarms..... | 1 | Backlighting Brightness..... | 5 |
| Test Your System Weekly | 1 | Internal Speaker Tone | 5 |
| Emergency Evacuation Plans..... | 2 | Volume level | 5 |
| Draw a floor plan of your home or business..... | 2 | Model Number | 5 |
| Develop escape routes..... | 2 | Keypad Address | 5 |
| Decide where to meet | 2 | Special Security Command Tones | 5 |
| Practice your escape plans | 2 | What to do when the trouble tone is sounding | 5 |
| Early detection | 2 | Special Security Command Displays | 6 |
| The Security Command Keypad | 3 | Special Wireless Displays | 7 |
| The Select keys..... | 3 | Understanding Security System Terms | 7 |
| Data Entry keys..... | 3 | | |
| COMMAND key..... | 3 | | |
| Back Arrow key | 3 | | |
| POWER LED..... | 3 | | |
| ARMED LED | 3 | | |
| 2-Button Panic Keys..... | 3 | | |

Arming and Disarming

| | |
|--|----|
| System Arming Operation | 9 |
| Arming the System | 10 |
| Quick Arming | 10 |
| Checking the Armed Areas | 10 |
| System Disarming Operation | 11 |
| Disarming the System from the keypad | 12 |
| Quick Disarming | 12 |
| Extending Schedules | 12 |

User Menu

| | |
|--|----|
| Accessing the User Menu | 13 |
| User Menu Options | 13 |
| Alarm Silence | 14 |
| Using the Alarm Silence Function | 14 |
| Sensor Reset | 14 |
| Resetting the Sensors | 14 |
| Door Access | 15 |
| Using the Door Access | 15 |
| Armed Areas Display | 15 |
| Using the Armed Areas Function | 15 |
| Outputs On Off | 16 |
| Turning the Outputs ON and OFF | 16 |
| Browser Feature | 16 |
| Zone Status | 17 |
| Using the Zone Status Function | 17 |
| Browser Feature | 17 |

| | |
|---|----|
| Bypass Zones | 18 |
| Using the Bypass Zones Function | 18 |
| Browser Feature | 18 |
| Zone Monitor | 18 |
| Testing your system's burglary protection | 18 |
| Using the Zone Monitor Function | 19 |
| Browser Feature | 19 |
| System Status | 19 |
| Using the System Status Function | 19 |
| System Test | 20 |
| Using the System Test Function | 20 |
| Using the Panic Zone Test | 20 |
| User Profiles | 21 |
| Adding User Profiles | 21 |
| User Profiles Chart | 22 |
| Deleting User Profiles | 23 |
| Changing User Profiles | 23 |
| TEMP CODE | 23 |
| ALLOW: 1 2 3 4 ANY | 23 |
| Browser Feature | 23 |
| User Codes | 24 |
| Adding User Codes | 24 |
| Browser Feature | 24 |
| Deleting User Codes | 25 |
| Changing User Codes | 25 |
| Browser Feature | 25 |
| Forgive Failure to Exit | 26 |
| Ambush Codes | 26 |

| | | | |
|---|----|---|----|
| Schedules..... | 27 | About the Display Events Section | 42 |
| Setting Shift (S1 S2 S3 S4) Schedules | 28 | Arming and Disarming Event Displays | 42 |
| Setting Output (OUT) and Door (DOOR) Schedules..... | 29 | Appendix A | |
| Setting Holiday ABC Schedules for S1, S2, S3, S4, OUT, and DOOR Schedules..... | 30 | Zone Event Displays | 42 |
| Setting Holiday Dates (HOL)..... | 31 | User Code Change Event Displays | 43 |
| Extending Schedules (EXT) | 31 | Supervisory Event Displays | 43 |
| Setting the Date and Time | 32 | System Monitor Event Displays..... | 43 |
| Setting the System's Date and Time..... | 32 | Door Access Event Displays..... | 44 |
| Display Events | 32 | About Door Access | 44 |
| Using the Display Events..... | 33 | Schedule Change Event Displays | 44 |
| Service Request | 34 | Zone Bypass Event Displays | 45 |
| Fire Drill | 34 | Appendix B | |
| Starting a Fire Drill test..... | 34 | Zone Status Browser | 46 |
| Ending a Fire Drill test | 34 | Bypass Zones Browser | 46 |
| System Setup | | Zone Monitor Browser | 47 |
| System Setup Record..... | 35 | Add User Codes Browser..... | 47 |
| Security Command Keypad Record | 35 | Delete User Codes Browser | 48 |
| Which keypads display System Status? | 36 | Change User Codes Browser | 48 |
| Which keypads display Armed Status? | 36 | Entering User Names..... | 49 |
| Which keypads provide Door Access reports? | 36 | | |
| Area Names and Numbers Record | 37 | | |
| User Profiles Record | 38 | | |
| User Codes Record | 39 | | |
| Schedules Record..... | 40 | | |
| Output Relay Record | 41 | | |

Appendix C

Easy Entry™ User's Guide 50
 DOOR STRIKE..... 50
 ARMING AND DISARMING AN AREA SYSTEM 50
 DISARMING WITH ENTRY DELAY 50
 Using the access reader for user menu access.... 50
Frequently asked questions..... 51
Common Keypad Displays 52

Index

Introduction

About Your Security System

For UL installations the Models XR500 and XR500N are listed for burglary and access control applications only. The XR500 and XR500N have not been investigated by UL for fire applications. No fire alarm devices shall be connected for UL installations.

The Security Command system has been designed with your safety and comfort in mind. It uses the latest in computer based technology to create the most advanced, user friendly security, fire, and access control system available.

The Security Command system combines ease of use with a simple to understand Security Command keypad to offer the full range of features requested by today's security system owners.

Use the Security Command system to turn portions of your protection on or off by pressing a few keys, or have the system turn on or off automatically by entering a simple schedule. You can add, delete, and change personal user codes at any time or check the status of protection devices in the system.

Parts of the System

There are two main parts to the Security Command system, the Security Command keypad and the keypad User Menu.

Security Command Keypad

This is the device we have placed at certain locations throughout the premises that allow you to turn the system protection on and off using your personal user code.

Keypad User Menu

The keypad provides a simple User Menu containing all of the functions you need to fully operate your system such as changing the time of day or a personal user code.**A Note About False Alarms**

One of the most important concerns facing the security industry today is false alarms. The accidental dispatching of police and fire agencies places others in jeopardy by limiting the response capability of those emergency service units. We take this concern seriously and have spent many hours training our employees to recognize the causes of false alarms and prevent them from occurring.

As part of our commitment to reducing false alarms, we would like to encourage you to read this guide thoroughly. All the information contained here can help you quickly, and comfortably, learn the Security Command system operation. If you have any additional questions, or feel that you need more training, please do not hesitate to contact us.

Test Your System Weekly

It is recommended that you test the burglary portion of your system at least once each week. Testing should involve an active test of all doors, windows, and motion detectors connected to your system. If your system also has fire protection, call the service department to find out how this portion of your system should be tested.

Refer to the System Test section of this guide for instructions on testing the burglary portion of your system and refer to the Fire Drill section for instructions on testing your system fire bells.

Emergency Evacuation Plans

The National Fire Protection Association recommends that you establish an emergency evacuation plan to safeguard lives in the event of a fire or other emergency.

Draw a floor plan of your home or business

On a clean sheet of paper, draw the walls, windows, doors, and stairs. Also draw any obstacles that a person may encounter while exiting the building such as large furniture or appliances.

Develop escape routes

Determine at least two routes the occupants in each room can take to safely escape. One route can be the most obvious such as the door. Another can be through a window that can be easily opened. If the window is high off the ground, an escape ladder should be provided.

Draw arrows on the floor plan to show escape routes from each room.

Decide where to meet

Prearrange a meeting place outside and away from where emergency personnel are likely to be working. A neighbor's house or across the street in front of the house are good locations. Always perform a head count to make sure all occupants safely exited. NEVER ENTER A BURNING BUILDING. If the head count shows one or more persons missing, give this information immediately to the authorities. Never enter a building to look for someone.

Practice your escape plans

Devising an escape plan is only the beginning. For the plan to be effective everyone should practice escape routes from each room.

Early detection

The best way to survive a fire or other emergency is to get out early. The installation of a fire alarm system, with smoke and carbon monoxide detectors in each room, can greatly decrease your risk of loss or injury.

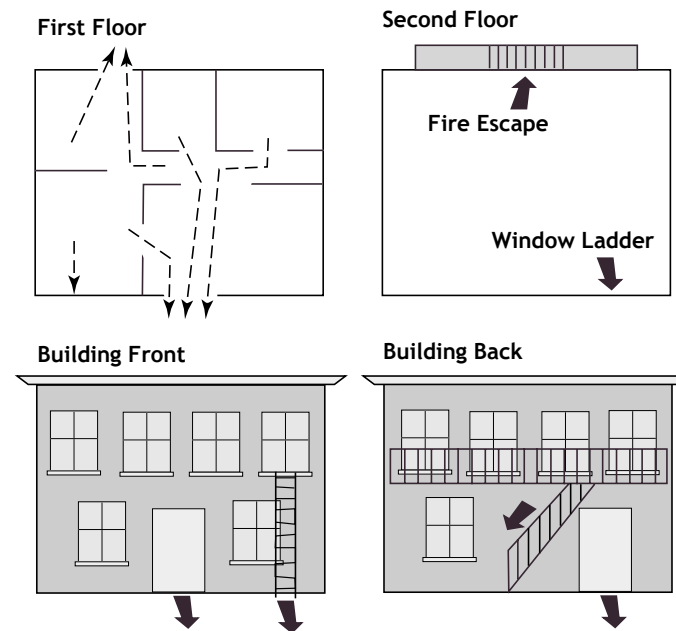

The Security Command Keypad

Your system may have one or more easy to use Security Command keypads that allow you to properly operate the system.

The Select keys

There are four keys under the display called the Select keys. These keys are one of the features that make your system so easy to operate. They allow you to make selections by pressing the Select key under a choice shown in the display.

For the purposes of this guide, when instructed to press the first Select key, press the far left Select key; the second Select key is the second from the left; third Select key is second from the right; and the fourth Select key is the far right key.

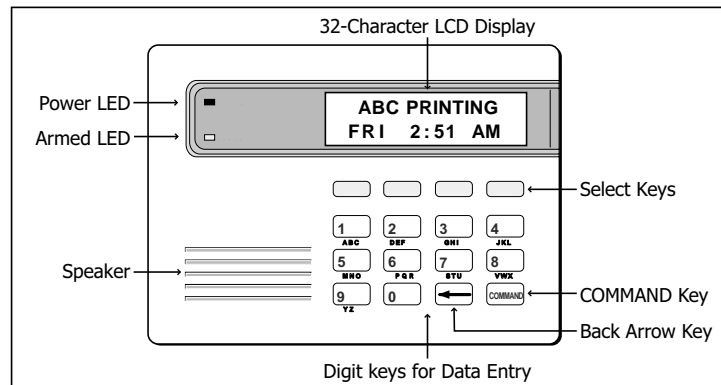

Data Entry keys

These keys allow you to enter your user code when arming or disarming or enter other information into the system.

COMMAND key

The COMMAND key allows you to advance through the keypad displays or User Menu or complete a data entry function.

Back Arrow key

The Back Arrow key is used to go back through the keypad displays while operating your system. You can press the Back Arrow key to back up through the list of functions in the User Menu or to erase the last character you entered.

POWER LED

This LED remains on steady as long as your system is connected to its AC power supply. Should there be an interruption, the LED turns off and the system backup battery maintains normal operation for a time so you can contact the service department.

ARMED LED

This LED is ON steady anytime a burglary protection area is armed and is OFF when ALL areas are disarmed.

2-Button Panic Keys

Your keypad may be set up to send a Panic, Emergency, or Fire report to the central station. This function is optional. An icon label should appear above the Select keys if this option is programmed for your keypad.

To send a panic, press and hold the two Select keys for 2 seconds, until a beep from the keypad is heard.

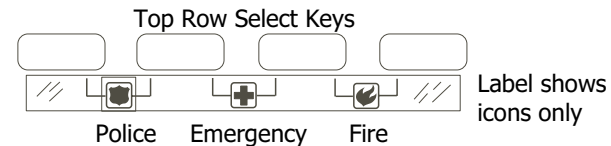

Using the Keypad

Keypad Displays Current Programming

Most User Menu options displayed at the keypad show the currently selected option in the panel memory. These options are either shown as a number, a blank, or a **NO** or **YES**. To change a number or blank to a new number, press any top row Select key. The current option is replaced with a dash. Press the number(s) on the keypad you want to enter as the new number for that prompt.

It is not necessary to enter numbers with leading zeros. The panel automatically right justifies the number when you press the **COMMAND** key.

To change a option that requires a **NO** or **YES** response, press the top row Select key under the response not selected.

For example, if the current prompt is selected as **YES** and you want to change it to **NO**, press the third top row Select key. The display changes to **NO**. Press the **COMMAND** key to go to the next prompt.

Multiple Displays Containing Programming

For many User Menu options, such as **User Profiles** and **Access Areas**, there will be several displays containing lists. For example, when using **Access Areas**, area 1 through 32 display on four separate displays. First, areas 1 through 8 display. Press the **COMMAND** key to display areas 9 through 16. Press the **COMMAND** key again to display areas 17 through 25. Press the **COMMAND** key one more time to display areas 26 through 32.

Note: If areas are not programmed to display at this keypad, you cannot view them.

Asterisks in Area Armed Displays

Asterisks display next to a programming option that is already selected. As shown in the example, options chosen to display the current programming selection have an asterisk next to the number. Those that are not selected simply display the number. In the **Devices** example, keypads 3, 8, 9, and 15 are not selected. In the **Areas** example, keypads 3, 8, 9, 15, 19, 23, 25, and 31 are not selected. In both examples the keypad numbers with asterisks are selected.

Devices

| | | | | | | | |
|----|----|----|----|-----|-----|-----|-----|
| *1 | *2 | 3 | *4 | 9 | *10 | *11 | *12 |
| *5 | *6 | *7 | 8 | *13 | *14 | 15 | *16 |

Areas

| | | | | | | | |
|-----|-----|-----|-----|-----|-----|-----|-----|
| *1 | *2 | 3 | *4 | *17 | *18 | 19 | *20 |
| *5 | *6 | *7 | 8 | *21 | *22 | 23 | *24 |
| 9 | *10 | *11 | *12 | 25 | *26 | *27 | *28 |
| *13 | *14 | 15 | *16 | *29 | *30 | 31 | *32 |

To select an option that is not already selected, simply enter the number using the digit keys on the keypad. To deselect an option, enter the number using the digit keys and the asterisk is removed.

This same scheme is used when viewing the panel armed status and other programming and operational functions. Remember to press the **COMMAND** key to display the rest of the device or area numbers.

User Options

The User Options allow you to make adjustments to your keypad to best fit your environment and needs.

To access the User Options portion of the keypad, press and hold the Back Arrow and COMMAND keys for two seconds. The keypad display changes to SET BRIGHTNESS. Press the COMMAND key to display the next option or the Back Arrow key to exit.

Backlighting Brightness

Set the brightness level of the keypad LCD, AC LED, and the Green keyboard backlighting. At the SET BRIGHTNESS display, use the left Select key to lower the keypad brightness. Use the right Select key to increase the brightness.

Note: If the brightness level is lowered, it temporarily reverts back to maximum intensity whenever a key is pressed.

Internal Speaker Tone

Set the tone of the keypad internal speaker. At the SET TONE display, use the top left Select key to make the tone lower. Use the right Select key to make the tone higher.

Volume level

Set the volume level of the keypad internal speaker for key presses and prewarn conditions. During alarm, trouble, and prewarn conditions, the volume is always at maximum level. At SET VOLUME LEVEL, use the left Select key to lower the keypad volume. Use the right Select key to raise the volume.

Model Number

The keypad's model number, firmware version, and date display, but cannot be changed.

Keypad Address

The keypad's current address displays, but cannot be changed. Press the Back Arrow key to exit the User Options function.

Special Security Command Tones

Your keypad also contains a small speaker that alerts you about events as they occur on your system.

Fire Alarm tone: An intermittent sweeping siren that sounds until the fire alarm is silenced. From LCD keypads only.

Burglary Alarm tone: A constant siren tone that continues until the alarm is silenced. From LCD keypads only.

Key press tone: A short beep each time you press a key on the keypad and it is acknowledged by the system.

Prewarn tone: A continuous pulsed tone that sounds when you open an entry delay door on a system that is armed (turned on) reminding you to disarm the burglary protection.

Monitor tone: A pulsed tone for one second, one pulse only that sounds whenever a door or window is opened while you are using the zone monitor function from the User Menu. LCD keypads sound a doorbell chime. See Zone Monitor.

Trouble tone: A steady tone indicating a trouble condition on your system. Press a Select key to silence.

What to do when the trouble tone sounds

You can silence the trouble tone by pressing any key. This only silences the keypad and does not correct the condition that originally caused the trouble.

Special Security Command Displays

As you use your system, you occasionally see a keypad display that asks you to enter a code or that describes a condition on the system. Below are some examples of the displays you will see:

ALARM

A 24-hour zone (for example fire or panic) or an armed burglary zone has been tripped. Your system may sound bells or sirens.

TROUBLE

There is a problem with a protection device or system component. This display is accompanied by a description of the problem.

ENTER CODE

The system requires you to enter your user code. User codes can be required for turning your system on (arming), turning your system off (disarming), and many other functions.

As you enter your user code, the keypad display shows an asterisk (*) in place of each digit pressed. This keeps others from seeing your user code on the display as it is entered.

TRY AGAIN or INVALID CODE

The user code you have entered is not recognized by the system. Check the user code and try again.

INVALID PROFILE

All user codes have a profile that allow the user to only access certain functions. When users attempt functions outside their authority, the INVALID PROFILE message displays.

INVALID AREA

A user has attempted a door access for an area they are not assigned.

INVALID TIME

A user code assigned to a specific schedule is entered outside of the valid schedule. See Schedules and User Codes.

ARMED AREA

A user has attempted a door access to an armed area to which they do not have arming and disarming authority.

FAILED TO EXIT (ANTI-PASS BACK)

Anti-pass requires users to properly exit (egress) an area they have previously accessed. If they fail to exit through the proper card reader location they are not granted access on their next attempt. If a Failed to Exit message appears, a user assigned the anti-pass back option has attempted to re-enter an area which they did not exit properly. The user must exit the area through the proper door. If not possible, your system administrator should select the Forgive option in the User Codes menu option.

SYSTEM TROUBLE or SERVICE REQUIRED

There is a problem with one or more of the components in your system. Contact our service department as soon as possible.

SYSTEM BUSY

The Security Command system is performing another task of a higher priority. This usually only takes a few moments.

Special Wireless Displays

Your system may use wireless transmitters to send alarm and trouble information from the protection devices to the panel. Wireless systems operate the same as hard-wired and also have a few unique keypad displays.

BACK DOOR - LOBAT - (Low Battery) The battery in a radio transmitter is low. (BACK DOOR is used as an example only.)

BACK DOOR - MISNG - (Missing) The panel is not receiving the radio transmitter periodic test report.

WIRELESS - TRBL - (Trouble) Some part of your wireless system is operating improperly. Test the system to locate the trouble.

Understanding Security System Terms

Throughout this guide, and in some displays on your keypad, you will see certain words or phrases that might be unfamiliar. Below are some terms you will see here and on your keypad display:

Access (Door Access)

Entry/Exit doors that are used to restrict access to the building or provide door access to authorized users. When a user code is entered at the keypad by entering a code or presenting a card to a reader, the system verifies authority and unlocks the door for a short period of time. See Easy Entry User's Guide in Appendix C.

Areas

An area is made up of burglary zones that can be armed or disarmed together. One area might consist of the office doors and windows. When you arm the office, these zones arm together and sound an alarm if opened.

Arming

Turning on the burglary protection in one or more areas of the system. When armed, the system is able to sound alarm bells or sirens and, if monitored, send alarm reports to a central station when a burglary zone is tripped.

Fire, panic, and other 24-hour devices are always turned on and do not need to be armed.

Fault

You may see the keypad display FRONT DOOR –FAULT. This means that there is a problem with the front door, such as the door being open when you are arming the system. If you see a –FAULT display, attempt to correct the problem (in this case shut the door). After the zone is in a normal state, you may arm the system. You may also bypass the zone and then arm the system.

Central Station Monitoring

Your system can also be programmed to automatically send alarm, trouble, and arming and disarming reports to a central station. Operators at the central station dispatch the appropriate authorities or contact you with the specific event information.

Disarming

Turning off one or more areas of the system. When disarmed, the system does NOT sound alarms or send alarm reports to a central station when a burglary zone faults.

Entry or Exit zone

Almost all systems have one or more doors through which you can access the premises. These doors are programmed with a delay time to allow you to enter or exit without setting off the alarm.

When you arm the system, activity on this zone is ignored until the exit delay time expires. Once that time has expired and the system is fully armed, opening the door causes the panel to start the entry delay time. During the entry delay time, you must enter a valid user code to disarm the system or an alarm will occur.

Status

Status is a feature that automatically displays the armed or disarmed status of your system on the Security Command keypads. Alarm or trouble conditions on a zone or a system monitor such as AC or battery trouble can also display. There are two types of status information available: Armed Status and Status List.

Armed Status

With Armed Status, the keypad displays the current armed condition of areas within your security system. Refer to Checking Armed Areas for information about checking the armed areas.

Keypads that include an Armed LED, have the Armed LED is ON steady anytime a burglary protection area is armed and OFF when ALL areas are disarmed.

Status List

The keypad Status List displays any alarm or trouble condition on a zone, and any trouble condition on an internal system monitor. The system monitors include the AC power, battery power, panel box tamper, printer, and phone lines. If more than one alarm or trouble condition occurs at the same time, the keypad sequences this information on its display.

If the alarm is from a 24-hour zone or a system monitor, it remains in the Status List until it restores. If one or more armed burglary zones trip at the same time, the last one to trip remains in the Status List. This is to ensure that if a burglary has occurred the last zone tripped remains displayed even if it has been restored.

View Zone Status

To view disarmed zones that are in fault, press any Select key when the status list displays.

Zone

A zone refers to one or more protected openings (doors or windows) or protection devices (motion or glassbreak detectors) grouped together under the same zone name and number.

Often, similar devices in the same general area share the same zone. For example, the windows on the east side of the premises can all be grouped together in a zone named E. WINDOWS.

Instant Zone

Interior protection devices and perimeter devices, such as exterior windows, passive infrared detectors (PIR), and non entry doors, are typically not programmed with delay times. If these zones are tripped while the system is armed, an alarm instantly occurs.

24-hour Zone

A 24-hour zone is not turned on or off by arming or disarming your system. Some examples of 24-hour zones are fire zones, panic zones, and temperature control zones.

Arming and Disarming

System Arming Operation

Area Assignment: Your security system has been set up into separate areas. The number of areas and their names are listed in the back of this guide.

Arming or Disarming: You can arm and disarm all areas at one time or each area individually. You can only arm or disarm areas authorized for your user code.

Arm all or Selective Arming: After entering your user code, the system allows you to arm either all of the areas to which you have access or one or more selected areas. If you choose to arm all areas, the system begins verifying that all zones in those areas are in a good condition. If you choose to arm selected areas, the system prompts you to choose the areas you want to arm.

After making your arming selection, the keypad displays any zones that are currently bypassed. These zones remain bypassed until the system is armed and then disarmed. Any 24-hour zones in a faulted condition also display.

Bypassing Zones: Before arming, the system verifies that all doors, windows, and other protection devices to be armed are in normal condition. If everything is verified, the system arms. If there is a problem on one or more burglary zones, the system cannot arm until the problem is corrected. If the problem is simply an open door or window, correct the problem and try arming again.

If the problem cannot be corrected, you can force arm or bypass the zone or wait until the zone can be repaired by a service technician. A force armed zone is ignored by the system until it restores to normal. A bypassed zone is ignored by the system during the entire armed period. A zone remains bypassed until the system is disarmed.

Arming and Disarming

In some cases, you might see the keypad display FRONT DOOR – FAULT. The keypad then displays priority zone which is a zone that cannot be bypassed. The problem on the zone must be corrected before the system can be armed.

Armed Message: After completing all zone bypasses or correcting all zone faults, the keypad briefly displays ALL SYSTEM ON if all areas in the system are arming and SYSTEM ON if only selected areas are arming. The keypad then displays the exit delay time as it counts down. When the exit delay time expires, all disarmed zones are armed.

If your system uses a keyswitch to arm an area, the exit delay time does NOT show on the keypad display.

ONE MOMENT . . . Message: If your system is monitored, it may be programmed to wait for the arming report transmission to the central station before displaying the armed message. (See Arming Report below.) This verifies your phone lines are working properly. While the system is waiting for the transmission, the display reads ONE MOMENT... If the report is received, the keypad displays the armed message. If the report is not received, the keypad displays LOCAL ALARM ONLY before displaying the armed message.

Arming Report: Your system can be programmed to send arming or zone bypassing reports to a central station. This feature is optional and can be programmed for you at any time.

Arming the System

1. Press the COMMAND key until ARM DISARM is displayed.
2. Select ARM to arm the system.
3. Enter your user code if required. The display reads ALL? NO YES.
4. Select NO to arm only selected areas. Go to step 5. Select YES to arm all areas authorized for your user code. Go to step 6.
5. If you selected NO in step 4, the display begins to list each area to which you have access followed by NO YES.
Example: OFFICE NO YES
 - 5a. Select YES for each area you want to arm.
 - 5b. Select NO for each area you do not want to arm.
6. The system displays any bypassed zones or faulted 24-hour or Priority zones. A faulted Priority zone cannot be armed.
7. At this point you can force arm or bypass any faulted zones. A zone that is force armed will be restored into the system if it later returns to normal. A zone that is bypassed will remain bypassed until the system is disarmed. See steps 7a through 7d.

- 7a. If a problem exists on a zone, the zone name and problem is shown followed by: OKAY BYPASS STOP.
- 7b. Select OKAY to force arm the faulted zone.
- 7c. Select BYPASS to bypass all faulted zones being displayed.
Note: 24-hour zones cannot be bypassed.
- 7d. Select STOP to stop the system from arming. Correct the zone problem(s) and return to step 1.
Your system may be programmed to require a user code that has authorization to force arm or bypass a faulted zone. To force arm or bypass a faulted zone, the system asks you to enter a user code.
8. The display reads SYSTEM ON if at least one area in the system is armed, and ALL SYSTEM ON if all areas in the system are armed.
9. The keypad then displays the exit time in seconds and counts down the remaining time: EXIT : ## (## = seconds remaining). The exit zones arm when the delay time expires.

Quick Arming

To quickly arm a desired area, enter the area number followed by the COMMAND key when the ALL? NO YES prompt displays.

Checking the Armed Areas

After you have armed the system, you may press any top row Select to check the armed areas when ALL SYSTEM ON or SYSTEM ON displays. The keypad then displays CHK ARMED AREAS: NAME NBR LIST.

Press the Select key under NAME to list all of the armed areas by name. Press the Select key under NBR to enter the number of the area you would like to check. Press the Select key under LIST to list all of the armed areas by number.

System Disarming Operation

While the system is armed, you can only enter the premises through an entry/exit delay door without causing an alarm. After opening the door, the Security Command keypad sounds a prewarn tone to remind you to disarm the system. (See Door Access Disarming below.) You must disarm the system before the entry delay time expires or an alarm on the door zone occurs.

During the entry delay time, the keypad displays ENTER CODE:. Enter your code to disarm the system. Only those areas assigned to your code disarms.

When you present your card to an outside reader to gain access and your code has authority to disarm, those areas assigned to the door which match areas assigned to your code automatically disarm. Enter code does not display.

Schedules: If you have programmed schedules for your system and a code is entered outside of a schedule and that code does not have authorization to disarm outside of schedules, the keypad displays INVALID TIME. This lets users know that they are disarming outside of their authorized time. If your system is monitored, an Unauthorized Entry report is sent to the central station.

All or Selective Disarming: After entering your user code, the system allows you to disarm either all of the areas to which you have access or just selected areas. If you choose to disarm all areas, the system automatically disarms them. If you choose to disarm selected areas, the area names display on the keypad.

Alarm Display: After disarming, the keypad displays any zones that tripped or any transmission problems that occurred during the armed period. All burglary zones are then disarmed and any bypassed zones are automatically reset.

Disarmed Message: The keypad displays ALL SYSTEM OFF after the system disarms.

Central Station Report: A report of the system disarming can be transmitted to the central station. This is optional and can be programmed for you at any time.

Door Access Disarming: Your system may be programmed to allow area disarming when a card is presented to a door access reader located outside of the building. Simply present your card to the reader and after the card code is validated for the appropriate authority, a door access is granted and your matching areas are automatically disarmed. See the Easy Entry™ User's Guide in Appendix C.

Disarming the System from the keypad

1. Press the COMMAND key until ARM DISARM displays. During entry delay this process starts at step 3.
2. Select DISARM to disarm areas.
3. The keypad displays ENTER CODE: . Enter your user code and press COMMAND. The keypad displays ALL? NO YES.
4. Select YES to disarm all areas authorized for your user code.
Select NO to disarm only certain areas individually. The keypad then displays the name of each area authorized for your user code followed by the NO YES display.
Choose YES to disarm the area displayed.
Choose NO to not disarm the area and display the next area.
5. After all areas have displayed, any alarms or communication problems that occurred during the armed period display.
6. If all areas have been disarmed, the keypad next displays ALL SYSTEM OFF.

Quick Disarming

To quickly disarm a desired area, enter the area number followed by the COMMAND key when the ALL? NO YES prompt is displayed.

Extending Schedules

Depending on your system programming, when the schedule expires (the ON time) you can extend the schedule to a later time. The keypad buzzer sounds and the keypad displays "area name" and LATE or CLOSING TIME!. This reminds users still on the premises to arm the system or extend the schedule.

To extend the system schedule:

1. Press a Select key. The keypad displays ENTER CODE:-.
2. Enter your code and press COMMAND or present your access card to a valid reader. The system schedule is automatically extended one hour.
3. The keypad then displays -: AM PM. You can enter a time to extend the schedule for greater than one hour. Press AM or PM.

Note: If the system is not armed by the scheduled closing time, a Late to Close report is sent to the central station. If the schedule is extended, a Schedule Change report is sent to the central station.

For information about extending a schedule before the scheduled closing time is reached, see Extending Schedules (EXT) in the User Menu portion of this guide.

User Menu

Many of your system features have been put into a User Menu that you can access from any Security Command keypad. The menu requires you to enter your user code and then it only shows those functions to which you have access.

Accessing the User Menu

1. Press the COMMAND key until MENU? NO YES displays.
2. Select YES. The keypad displays ENTER CODE: -. Enter your user code and press COMMAND. You can now scroll down through the list of system features available to you.

User Menu Options

The list below shows the User Menu options in order:

| Menu Option | Description |
|-------------|-------------|
|-------------|-------------|

| | |
|----------------|--|
| ALARM SILENCE | Silences an alarm bell or siren. |
| SENSOR RESET | Resets smoke or glassbreak detectors that have latched due to an alarm condition. |
| DOOR ACCESS | Momentarily opens the keypad door lock relay. |
| ARMED AREAS | Displays the name of any areas in the system that are currently in the armed state. |
| OUTPUTS ON/OFF | Allows you to turn on or off any of the outputs described in the System Setup section of this guide. |
| ZONE STATUS | Allows you to see if a zone is either armed, bypassed, in alarm, open, or shorted. |

| | |
|-----------------|--|
| BYPASS ZONES | Allows you to Bypass a zone or reset an already bypassed zone. |
| ZONE MONITOR | Allows you to add or remove a zone from the monitor mode. |
| SYSTEM STATUS | Displays the current condition of the system AC power, backup battery, and optional panel tamper. |
| SYSTEM TEST | Tests the system's siren, communication to the central station, and backup battery. |
| USER PROFILES | Allows you to change user profiles. |
| USER CODES | Allows you to add, delete, or change user codes. |
| SCHEDULES | Allows you to add, remove, or change system schedules. |
| TIME | Allows you to change the Day, Date, or Time that is currently programmed in the system. |
| DISPLAY EVENTS | Allows you to view or print the last 10,000 door accesses or 2,000 system events that occurred on your system. |
| SERVICE REQUEST | Allows you to send a message to the Central Station requesting service on the alarm system. |
| FIRE DRILL | Allows you to test the system's fire bells. |

Alarm Silence

Silences the alarm bells or sirens during an alarm.

Alarm Silence allows you to turn off the alarm bells and sirens connected to your system during an alarm. Using Alarm Silence does NOT stop an alarm report from being sent to the central station and does not reset any alarmed devices. Use the Sensor Reset function to reset devices such as smoke detectors that have latched in alarm.

Note: You can also silence an alarm by entering your user code and pressing COMMAND or by presenting your card to a reader while the Status List displays. Matching areas assigned to your code are disarmed and door access occurs.

Using the Alarm Silence Function

1. Access the User Menu.
2. The keypad displays ALARM SILENCE?.
3. Press any Select key to silence the bells and exit the User Menu.

Sensor Reset

Resets smoke or glassbreak detectors. Also clears Fire/Supervisory alarm and trouble displays.

Sensor Reset is used to reset smoke and glassbreak detectors after they have tripped. Once these detectors trip, they must be reset before they can detect any additional alarm conditions. When you select Sensor Reset, power to the detectors is temporarily removed by the system allowing them to reset.

Make sure all smoke is cleared from around the area of the smoke detectors before performing a Sensor Reset to prevent the alarm from occurring again.

Resetting the Sensors

1. Access the User Menu.
2. Press COMMAND until SENSOR RESET displays.
3. The keypad displays SENSORS OFF for five seconds followed by SENSORS ON.
4. The keypad automatically exits the User Menu.

Door Access

Operates an electric door strike from the keypad.

Door Access is used to operate the door strike relay that is built into some Security Command keypads. Power for the door strike is connected to the keypad relay and can be interrupted by using the Door Access function.

When Status List displays, you can operate Door Access by simply entering your user code and pressing COMMAND. See Easy Entry™ User's Guide in Appendix C. If you are using a 793 keypad that has a built-in card reader, you may simply present your card to be allowed Door Access.

A report of this entry can be sent to your central station. This report is optional and can be programmed for you at any time.

Using the Door Access

1. Access the User Menu.
2. Press COMMAND until DOOR ACCESS? displays.
3. Press any Select key. The door strike relay turns on momentarily.
4. The keypad returns to the Status List display.

Armed Areas Display

Displays all armed area names in the system.

The Armed Areas display lists all of the names of the armed areas in your system at the Security Command keypads.

Using the Armed Areas Function

1. Access the User Menu.
2. Press COMMAND until ARMED AREAS? displays.
3. Press any Select key. The keypad displays the first armed area name. To scroll through the list of armed area names, press the COMMAND key.
4. If there are no armed areas, the keypad displays NONE.

Outputs On Off

Allows you to manually turn the system or door access relay outputs ON and OFF.

This function is used to individually turn your system relay and access door outputs ON and OFF. Your system may use these outputs to control door access, interior and exterior lighting, heating, air conditioning, or other appliances.

The names and numbers of the relays connected to your system are located in the System Setup section of this guide.

Outputs can be turned ON or OFF regardless of the output settings in Schedules.

Your system may be programmed to require that your user code profile have access to areas assigned to the keypad. INVALID AREA displays when your user code does not have access to the keypad's areas and the output does not turn on.

Under certain conditions, some outputs cannot be turned on. If you select a restricted output, the keypad displays CANNOT TURN ON.

Turning the Outputs ON and OFF

1. Access the User Menu.
2. Press COMMAND until OUTPUTS ON/OFF? displays.
3. Press any Select key to display OUTPUTS DOOR.
4. Select the type of output you want to turn ON or OFF by pressing the Select key under OUTPUTS or DOOR.
5. Enter the output number you want to turn ON or OFF. The output number displays. The range for outputs is 1-6, 500-999. The range for the door is 1-16.
6. With the output number displayed, press the Select key under ON or OFF. The output then turns ON or OFF depending on your Selection, and remains in that state until you change it. The keypad displays the first 12 characters of the output or door name followed by either ON or OFF for four seconds to provide visual verification of the action. Press the COMMAND key to end the four second display.
7. The system automatically returns to the output or door prompt and a new output can be selected to turn ON or OFF. Refer back to step 4.
8. Press the Back Arrow key to exit the User Menu.

Browser Feature

If you are unsure of the output number, refer to Appendix B at the back of this guide for a diagram showing you how to use the built-in Outputs ON/OFF browser.

Zone Status

Displays a list of armed, bypassed, or alarmed zones. Also allows you to check the status of individual zones. Zone Status can be used to give you a list of zones by category or display the current status of an individual zone number. The four categories are:

- Armed Zones - zones that are currently armed.
- Bypassed Zones - zones that are currently bypassed.
- Alarmed Zones - zones that have gone into alarm during the current or previous armed period.
- Number - enter the number of any zone to check its status.

Using the Zone Status Function

1. Access the User Menu.
2. Press COMMAND until ZONE STATUS? displays.
3. Press any Select key to display ARM BYPS ALR NBR.
Select ARM for a list of zones that are currently armed. You can scroll through the list by pressing the COMMAND key.
Select BYPS for a list of zones that are currently bypassed.
Select ALR for a list of zones that have gone into alarm during the current or previous armed period.
Press NBR and ZONE NO: - displays.

8. At the ZONE NO: - prompt, enter the zone number you want to check and press COMMAND. The zone number and name display followed by the zone status. For example, a zone status for zone 1 might be BACK DOOR - OKAY.

Below is a list of the zone status displays:

- OKAY = the zone is in a normal condition
- BYPAS = the zone is bypassed
- BAD = the zone is in a bad or faulted condition

9. After displaying the zone status, ZONE: - returns for you to enter another zone number.

Browser Feature

If you are unsure of the zone number or description, refer to Appendix B at the back of this guide for a diagram showing you how to use the built-in Zone Status browser.

Bypass Zones

Allows you to bypass a zone prior to arming.

Bypassing is usually done when a zone cannot be restored to normal. A significant benefit of bypassing a zone is to allow a zone in a faulted or bad condition to be bypassed so arming can occur. The faulted zone can be serviced the next day.

A zone can be bypassed only while it is disarmed. Fire, panic, emergency, and supervisory type zones are always armed, so they can never be manually bypassed.

Bypass Zones can also be used to reset a zone that has been bypassed and restore it back into the system.

When Bypass Zones is selected, a report can be transmitted to your central station.

Using the Bypass Zones Function

1. Access the User Menu.
2. Press COMMAND until BYPASS ZONES? displays.
3. Press any Select key. The keypad displays ZONE: - RST BYPS.
4. To Bypass a zone, enter the zone number and select BYPS. The zone number automatically disappears and a new zone number can be entered. Refer back to step 3.
5. To Reset a zone, enter the zone number and select RST.

Browser Feature

If you are unsure of the zone number or description, refer to Appendix B at the back of this guide for a diagram showing you how to use the built-in Bypass Zones browser.

Zone Monitor

Allows the system to monitor selected disarmed zones (doors, windows, or motion detectors) and display their name at the keypad as they are faulted. This feature could be used to monitor an access door.

Zone Monitor works with any disarmed zone and also sounds the keypad monitor tone when the zone faults. The zone name displays at all keypads designated for the area in your system.

You can place any combination of disarmed zones in Zone Monitor but only the most recent zone faulted displays. The displayed zone name clears automatically after a short time or when the zone is armed.

Testing your system's burglary protection

After using the System Test function, place all zones in Zone Monitor. Starting at the front door, go around and open and then close each door and window. You should hear the keypad beep each time. The keypad also displays the name of each zone as its device is opened.

Once the protected doors and windows test is complete, walk in front of each motion detector. The keypad should beep to confirm the zone has tripped. If at any time during your weekly testing a device does not cause the keypad to beep, call the service department for assistance.

Using the Zone Monitor Function

1. Access the User Menu.
2. Press COMMAND until ZONE MONITOR? displays.
3. Press any Select key. The keypad displays ALL NBR.
4. Select ALL to place all disarmed zones into Zone Monitor.
 - 4a. The keypad displays ALL? ADD RMV.
 - 4b. Select ADD to add all disarmed zones to Zone Monitor.
 - 4c. Select RMV to remove all disarmed zones.
5. Select NBR to enter a specific zone number for zone monitor.
6. If you select NBR, the keypad displays ZONE: - ADD RMV.
 - 6a. Enter any zone number and select ADD to add this zone.
 - 6b. Enter any zone number and select RMV to remove this zone.
7. The zone number automatically disappears. You can then enter a new zone number and repeat step 6a or 6b.

Browser Feature

If you are unsure of the zone number or description, refer to Appendix B at the back of this guide for a diagram showing you how to use the built-in Zone Monitor browser.

System Status

Displays the current condition of internal system hardware.

System Status shows the panel condition of AC power, battery power, and optional panel tamper. When System Status is selected, each monitor displays followed by OKAY or TRBL (Trouble) to indicate the current condition.

Using the System Status Function

1. Access the User Menu.
2. Press COMMAND until SYSTEM STATUS? displays.
3. Press any Select key. The display starts listing each system monitor and status.

For example: AC POWER - OKAY

Below are the System Monitor displays:

| Keypad Display | What it monitors |
|----------------|------------------|
| AC POWER | AC power |
| BATTERY | Battery power |
| TAMPER | Panel box tamper |

These are followed by either OKAY or TRBL (trouble).

If TRBL displays, call the service department for assistance.

4. The system then displays its firmware version (for example, VER_201_4/15/03), the panel model (MODEL XR500), and then exits the User Menu.

System Test

System Test is used to test the battery, alarm bell or siren, and communication to a central station. The System Test function begins automatically as soon as you select it.

Using the System Test Function

1. Access the User Menu.
 2. Press COMMAND until SYSTEM TEST? displays.
 3. The keypad displays SYSTEM PANICS. Press the Select key below SYSTEM.
 3. The System Test begins automatically and the keypad displays the following messages in this order:
 - 1) **BELL SOUNDING** during a two second bell test
 - 2) **BATTERY - OKAY** or **BATTERY - TRBL** to indicate the battery condition
 - * 3) **TRANSMIT TEST** and **ATTEMPT NO : 1** during the transmit test
 - 4) **TRANSMIT OKAY** or **TRANSMIT FAILED** to show the results of the transmit test
 - 5) **TEST END** to indicate the System Test is complete.
 - 6) You can press the Back Arrow key to end the transmit test.
- * The transmit test does not operate on local systems.

Using the Panic Zone Test

1. Access the User Menu.
2. Press COMMAND until SYSTEM TEST? displays.
3. Press any Select key. The keypad displays SYSTEM PANICS.
4. Press the Select key below PANICS.
5. The Panic Zone Test begins automatically and the keypad displays TRIPS: END.

During the Panic Zone Test, trip each panic zone (or button) on the system by pressing and holding the panic for 1 to 2 seconds.

Note: You do NOT have to hold the panic for 2 seconds in normal mode. You are only required to hold the panic during the Panic Zone Test because the zone takes additional time to report when the system is in test mode.

Each time you trip a panic zone, the display number increments and the keypad buzzer sounds for two seconds.

The number of panic zones tripped constantly displays until the test ends or no panic zone activity has occurred for 20 minutes.

6. Press the Select key below END to stop the Panic Zone Test.
7. PANIC TEST OKAY displays when the Panic Zone Test is completed and all zones tested OK.
8. When the Panic Zone Test ends and a zone failed (did not trip) during the test, the keypad displays the zone name and number and the buzzer sounds for one second. Press the COMMAND key to display the next failed zone.

Note: During the Panic Zone Test, any zones that fail are not sent to the receiver or to the pager.

User Profiles

Add, delete, or change User Profiles, that define the authority of each user code in the system. Several characteristics define the authority of each User Profile within the system.

Profile Number - Each profile may be assigned a unique number from 1 to 99.

Profile Name - Each profile may be assigned a 16-character name. The Profile Number is the default name.

Area Number - Each profile may be assigned specific areas of the system for arming and disarming. When profiles 1 to 98 are created, NO areas are assigned by default. The default for profile 99 is ALL areas assigned. Profile 99 is predefined in the system by the factory.

Access Area Number - Each profile may be assigned door access area assignments. Default for profile 1 to 98 is NO areas assigned. Default for profile 99 is ALL areas assigned. Profile 99 is predefined at the factory.

Output Group Assignment - Each profile may be assigned an output group number from 1 to 10. Default for profile 1 to 98 is NO output group assigned. Default for profile 99 is output group 10. Your system may be programmed to turn on an output group at certain keypads when door access occurs.

User Menu Assignments - Each user profile may have any of the menus assigned to it as shown in the User Profile Record below. The User Profile Record lists the user menu profile assignments and the system functions users are allowed to access based on the profile numbers assigned to their codes.

Always make sure that at least one administrator in your system has a profile with **all** authorities and **all** areas.

User Menu

Adding User Profiles

1. Access the User Menu. Press COMMAND to USER PROFILES?.
2. Press any Select key. The keypad displays ADD DEL CHG. Press the Select key under ADD, to add a new user profile.
3. At the PROFILE NO: - prompt, enter an unused profile number and press COMMAND. The display changes to PROFILE NAME.
4. Press any Select key. Enter a profile name of up to 16 characters. Press COMMAND. See Appendix B.
5. At the ARM/DIS AREAS: prompt, select the area numbers (1-32) for arming and disarming assigned to this profile.
6. The keypad displays ACCESSAREAS: . Select the area numbers (1-32) assignment to allow door access for this profile. Press the COMMAND key.
7. The keypad displays OUTPUT GROUP: -. Enter the number (1-20) for the Output Group assigned to this profile. Press the COMMAND key.
8. The keypad displays each of the menus as shown in the Profile Table on the following page for you to enable for this profile number. Select YES or NO and press the COMMAND key to advance to the next menu Selection.
9. When you have completed selecting all User Profile menu assignments, the keypad displays the PROFILE ## ADDED message for 4 seconds.

User Profiles Chart

| Menu Display | | | Privilege | Profile Number | | | | | | | | | | | | |
|--------------|-----|-----|--------------------------|----------------|------|-----|-----|-----|-----|-----|-----|-----|-----|-------|-----|-----|
| | | | | 1 | 2 | 3 | 4 | 5 | 6 | 7 | 8 | 9 | 10 | 11-98 | 99 | |
| ARM/DIS | NO | YES | Arm and Disarm | No | Yes | Yes | Yes | Yes | Yes | Yes | Yes | Yes | Yes | No | No | Yes |
| ALM SLNC | NO | YES | Alarm Silence | No | Yes | Yes | Yes | Yes | Yes | Yes | Yes | Yes | Yes | No | No | Yes |
| SNSR RST | NO | YES | Sensor Reset | Yes | Yes | Yes | Yes | Yes | Yes | Yes | Yes | Yes | Yes | No | No | Yes |
| DOOR ACS | NO | YES | Door Access | Yes | Yes | Yes | Yes | Yes | Yes | Yes | Yes | Yes | Yes | Yes | No | Yes |
| ARM AREA | NO | YES | Armed Areas | Yes | Yes | Yes | Yes | Yes | Yes | Yes | Yes | Yes | Yes | No | No | Yes |
| OUTPUTS | NO | YES | Outputs ON/OFF | No | No | No | No | Yes | Yes | Yes | Yes | Yes | Yes | No | No | Yes |
| ZN STATS | NO | YES | Zone Status | Yes | Yes | Yes | Yes | Yes | Yes | Yes | Yes | Yes | Yes | No | No | Yes |
| BYPAS ZN | NO | YES | Bypass Zones | No | No | No | No | No | Yes | Yes | Yes | Yes | Yes | No | No | Yes |
| ZONE MON | NO | YES | Zone Monitor | No | No | No | Yes | Yes | Yes | Yes | Yes | Yes | Yes | No | No | Yes |
| SYS STAT | NO | YES | System Status | Yes | Yes | Yes | Yes | Yes | Yes | Yes | Yes | Yes | Yes | No | No | Yes |
| SYS TEST | NO | YES | System Test | No | No | No | Yes | Yes | Yes | Yes | Yes | Yes | Yes | No | No | Yes |
| PROFILES | NO | YES | User Profiles | No | No | No | No | No | No | No | No | Yes | No | No | No | Yes |
| USR CODE | NO | YES | User Codes | No | No | No | No | No | No | No | No | Yes | No | No | No | Yes |
| SCHEDULS | NO | YES | Schedules | No | No | No | No | No | No | Yes | Yes | Yes | Yes | No | No | Yes |
| TIME | NO | YES | Time | No | No | No | No | No | No | No | Yes | Yes | Yes | No | No | Yes |
| DIS EVNT | NO | YES | Display Events | Yes | Yes | Yes | Yes | Yes | Yes | Yes | Yes | Yes | Yes | No | No | Yes |
| SERV REQ | NO | YES | Service Request | No | No | No | No | No | No | No | Yes | Yes | Yes | No | No | Yes |
| FIRE DRILL | NO | YES | Fire Drill | No | No | No | No | No | No | No | Yes | Yes | Yes | No | No | Yes |
| EXTEND | NO | YES | Extend Schedules | No | No | No | No | No | Yes | Yes | Yes | Yes | Yes | No | No | Yes |
| TEMP CODE | NO | YES | Temporary User Code | No | No | No | No | No | No | No | No | No | No | No | No | No |
| ANTI PASS | NO | YES | Anti-Passback | No | No | No | No | No | No | No | No | No | No | No | No | No |
| ALLOW: 1234 | ___ | ANY | Allow: Shift/Time Access | 1234 | 1234 | Any | Any | Any | Any | Any | Any | Any | Any | Any | Any | Any |

Deleting User Profiles

1. Access the User Menu.
2. Press COMMAND until USER PROFILES? displays.
3. Press any Select key. The keypad displays ADD DEL CHG.
4. Press the second Select key, under DEL, to delete a user profile.
5. At the PROFILE NO: - prompt, enter a profile number and press COMMAND. The display changes to DELTD.

Note: User codes assigned to deleted profiles will not function.

Changing User Profiles

1. Access the User Menu.
2. Press COMMAND until USER PROFILES? displays.
3. Press any Select key. The keypad displays ADD DEL CHG.
4. Press the far right Select key, under CHG.
4. At the PROFILE NO: - prompt, enter a profile number and press COMMAND. The display changes to PROFILE NAME.
5. Press any Select key to display -. Enter a profile name of up to 16 characters. The default Profile Name uses the Profile Number. Enter the name and press COMMAND.
6. At the Arm/Dis AREAS: prompt, enter the area numbers (1-32) for arming and disarming assigned to this profile.
7. The keypad displays ACCESS Areas: . Enter the area numbers (1-32) assignment to allow door access for this profile. Press the COMMAND key.
8. The keypad displays OUTPUT GROUP: -. Enter the number (1 through 20) for the Output Group assigned to this profile. Press the COMMAND key.

9. The keypad displays each of the menus as shown in the Profile Table. You then enable or disable the menu function for this profile number. Select YES or NO and press the COMMAND key to advance to the next menu selection.
10. When you complete Selecting all User Profile menu assignments, the keypad displays the PROFILE CHNGD message for 4 seconds, indicating the profile is changed.

TEMP CODE

When you select YES for this menu option, and this profile is assigned to a user code (see next section), the keypad displays TEMP EXPIRE DATE:. Enter the ending date for the profile to expire. Default is seven days from today. The system deletes Temp users at 12:00 AM on the last date.

ANTI PASS NO

Anti-passback requires that you properly exit (egress) an area previously accessed. If you fail to exit through the proper location you cannot access it until you properly exit. Default is No. See page 6 for more information.

ALOW: 1 2 3 4 ANY

This menu option defines the time schedules that the User Code operates for door access and disarming. Selecting 1, 2, 3, and/or 4 indicates operation during the S1-S4 shift schedules. Selecting ANY (fourth Select key) from the menu indicates the code operates any time, regardless of schedules. You may select all shift schedules for one user. Menu access is not affected by this option. An UNAUTHORIZED ENTRY message is sent to the central station if disarming occurs outside the open/close schedule.

Browser Feature

Refer to Appendix B in this guide for a diagram showing you how to use the Output Group browser and the Profile browsers.

User Codes

This option allows you to add, delete, or change a user code. You may also assign specific User Profiles to individual users.

1234 = User Number
34812 = User Code
John Smith = User Name
7 = Profile

User Number - Every user is numbered 1 through 9999. This number identifies the user to the system and is transmitted to the central station when the user arms or disarms areas.

User Code - Each user also has a 3 to 5 digit number, below 65535, to enter into the Security Command keypad when arming or disarming the system.

Note: A User Code cannot begin with zero and 3-digit codes cannot begin with 98.

For UL installations, avoid using repetitive (111) or sequential (123) codes.

User Names - Each code may also be programmed with the user name. You may enter up to 16 characters for the name.

User Profile - The user is also assigned a Profile (1 to 99) by the person administrating the system. The profile number determines the areas and functions the user can access.

Adding User Codes

1. Access the User Menu.
2. Press COMMAND until USER CODES? displays.
3. Press any Select key. The keypad displays
ADD DEL CHG BAT.

4. Press the Select key under ADD or BAT (Batch) to add a new user code.
5. At the USER NUMBER: - prompt, enter a user number and press COMMAND. The display changes to CODE NO: - .

Note: Do NOT program a code for user number 1 unless you intend to use the Ambush function. See Ambush.

6. Enter a user code of 3 to 5 digits and press COMMAND. The user enters this number to arm, disarm, etc. If using access cards, present the card instead of entering a code. After entering the code the keypad displays USER NUMBER ### as the user name.
7. A 16-character name may be entered to identify the user. Press any top row key to clear the current name. You may then enter the new name. After entering the name press COMMAND. See Entering Names in Appendix B.
8. The display changes to PROFILE NO: -. Select the profile number to assign a set of authorized functions to the user code as outlined in the Profile Table on the previous page.
9. At the PROFILE NO: - display, enter a profile number from 1 to 99, and press COMMAND. The display shows USER # ADDED.

If BAT (Batch) was chosen in step 4 instead of ADD, the next available user number is automatically selected and only steps 6 and 7 repeat. The User Profile assignment is automatically selected for the next user based on the previous user entered. This batch entry method speeds up user entry in large systems.

Browser Feature

Refer to Appendix B at the back of this guide for a diagram showing you how to use the User Profiles Change browser.

Deleting User Codes

1. Access the User Menu.
2. Press COMMAND until USER CODES? displays.
3. Press any Select key. The keypad displays ADD DEL CHG BAT.
4. Press the second Select key, under DEL, to delete a user code from the system. To delete a user code, you must have a user code with a profile that has user code authority.

Note: Your system must have at least one user with user code authority in order to be able to add or delete user codes. Be careful not to delete all users with user code authority from your system. Also, the user code used to enter the user menu to delete codes cannot be deleted. In other words, you can not delete yourself.

5. At the USER NUMBER: - prompt, enter the user number you want to delete and press COMMAND. The display changes to USER # DELETED.
6. The display then changes back to USER NUMBER: - allowing you to delete another user. Press the Back Arrow key twice to exit the User Menu.

Changing User Codes

1. Access the User Menu.
2. Press the COMMAND key until USER CODES? displays.
3. Press any Select key. The keypad displays ADD DEL CHG BAT.
4. Press the third Select key, under CHG, to change a user code.
5. At the USER NUMBER: - prompt, enter the user number to change and press COMMAND.

Refer to the System Setup section for the number of user codes available for your system.

6. The display changes to CODE NO: *****. Press a Select key and enter the new user code. Press COMMAND.
7. The display then shows the current user name. Press any top row key to clear. See Entering Names in Appendix B to enter a new name.

Note: Changing a user code does not change the user number.

8. The display changes to PROFILE NO: -. Select the profile number to assign a set of authorized functions to the user code as outlined in the Profile Table on page 11.
9. After entering the profile number, the keypad displays USER # CHANGED for 5 seconds followed by USER NUMBER: -. This display allows you to enter another user number to change. Press the Back Arrow key twice to exit the User Menu.

Browser Feature

Refer to Appendix B for diagrams showing you how to use the User Codes Add, Delete, and Change browsers.

Forgive Failure to Exit

Failure to Exit is an Anti-pass back violation in which a user assigned with anti-pass back has attempted to re-enter an area that they did not exit through.

Forgive Failure to Exit removes the anti-pass back violation. See page 6 for more information about anti-pass back.

1. After the USER CODES? menu is accessed and ADD DEL CHG BAT displays, press COMMAND. The keypad displays FRGV.
2. Press the top left key. The display changes to USER NUMBER:
3. At the USER NUMBER:- prompt, enter the user number to be forgiven and press COMMAND. The User Code Browser described in the Appendix can help find the appropriate user by name if you do not know the number.
To clear the FAILURE TO EXIT (Anti-pass back) violation for all users enter 000 at the USER NUMBER:- prompt.
4. The keypad displays USER XXXX FORGVN to confirm, then returns to step 3 for the next user. Press the Back Arrow key to exit this menu.

Ambush Codes

Your system may be programmed to allow user number 1 to be used as an Ambush code. This Ambush code functions identically to a standard code with the exception that it sends a silent alarm to the central station. This silent alarm alerts the operator to a duress situation at the premises and prompts immediate notification of authorities.

Refer to the System Setup section of this guide to see if your system is programmed for Ambush. If so, do NOT program a code for user number 1 unless you intend to use the Ambush function.

Schedules

Schedules are ideal for individual area auto arming and disarming and for creating Opening/Closing windows during which users can access the building or disarm the system. Having separate schedules allows you to create Opening/Closing windows for each day. One could be for normal business activity and another could be for cleaning crews or a second shift. Once programmed, these schedules operate continually until changed.

The Schedules function allows you to program into the system the times at which you normally turn your burglary protection on and off each day of the week. This information can then be used by the system to automatically arm or disarm the burglary protection.

If your system does not use automatic arming, you can use the Closing Check/Extend feature with Schedules to help ensure your system is armed manually at a specific time. This option sounds the keypad buzzer and displays CLOSING TIME! or AREA LATE! when a schedule expires. This reminds users still on the premises to arm the system or extend the schedule to a later time.

Your system provides you with five different types of schedules:

Shift (S1, S2, S3, S4) allow you to set access and disarm schedules that occur at the same time each day until you change them. Users are assigned to shifts using the ALLOW authority.

Output (OUT) schedules allow you to set the times when relay outputs or door strikes connected to your system turn ON and OFF automatically.

Door (DOOR) schedules allow you to set times when door strikes turn ON and OFF automatically.

Holiday (HOL) dates allow you to enter special dates which activate Holiday Schedules that supersede all other schedules.

Extend (EXT) schedules allow you to set a time for a one time extend of the currently running shift (S1 - S4) schedule.

Setting Shift (S1 S2 S3 S4) Schedules

1. Access the User Menu and press COMMAND until SCHEDULES? displays. Press any Select key.
2. The keypad displays S1 S2 S3 S4. Press the Select key under the shift you want to program. This will allow you to enter a schedule that remains in place until you change or delete it.
3. Your system may be programmed to allow four shift schedules per area, if so, AREA NO:- displays. Enter the area number that you want to assigning to this schedule. Press the COMMAND key to accept your Selection and continue setting schedules.
4. The keypad displays SUN MON TUE WED. Press the COMMAND key to display THU FRI SAT HOL. Press the Select key under the day you want the schedule to begin. If you select HOL, go to Setting Holiday ABC Schedules for additional instructions.

Note: After Selecting the day of the week or holiday for the schedule to begin, the keypad displays any currently programmed Opening and Closing times previously set for that day. This feature allows you to review programmed schedules at any time.

A schedule entered in HOL (holiday) activates and overrides SUN MON TUE etc. schedules anytime a holiday date occurs.

5. If Opening and Closing times display, the keypad then displays DELETE KEEP. Press the Select key under DELETE to enter new times.
6. The keypad then displays OPENING TIME? followed by the display MON - : AM PM. Enter the new opening time and select AM or PM.
Enter all schedule times using a 12 hour clock. For example, to enter 6 AM you would enter a 0 + 6 + 0 + 0 and press the Select key under AM. For 11 PM you would enter a 1 + 1 + 0 + 0 and press the Select key under PM.
The keypad then displays CLOSING TIME? followed by the display MON - : AM PM. Enter the new closing time and select AM or PM. Pressing the Select key under whichever day displays, for example, MON, allows you to scroll through the days of the week and create a schedule window that spans multiple days.
Note: You must enter an Opening and Closing time or the system will not recognize the schedule.
The new schedule is now programmed into your system.
7. The keypad goes back to the SUN MON TUE WED display allowing you to enter another schedule.
8. To clear a schedule press DELETE and then AM when the opening time is requested.
Press the Back Arrow key to exit the User Menu.

Setting Output (OUT) and Door (DOOR) Schedules

The Schedules function allows you to set up to 100 different scheduled times for relay outputs and door access relays connected to your system to turn ON and OFF automatically. The maximum number of schedules that can be assigned per door access relay or relay output is 8.

1. Access the User Menu.
2. Press COMMAND until SCHEDULES? displays.
3. After you have accessed the SCHEDULES? menu and the schedule options, S1 S2 S3 S4, display, press the COMMAND key once more and the display changes to OUT DOOR HOL EXT. Press the Select key under OUT or DOOR.
4. At the OUTPUT NO: - or DOOR NO: - display, enter the output or door number you want to program. Press the COMMAND key.

If adding a schedule and all 100 scheduled times are currently in use, OUT SCHEDS FULL displays. You must then delete an existing schedule.

5. The keypad displays SCHEDULE NO: -. Enter the schedule number (1 to 8) and press the COMMAND key.
6. The keypad displays SUN MON TUE WED. Press the COMMAND key to display THU FRI SAT HOL.
7. Press the Select key under the day you want to program. If you select HOL go to Setting Holiday ABC Schedules for more information.

Note: After Selecting the day of the week for the schedule to occur, the keypad displays any currently programmed ON OFF times previously set for that day. This feature allows you to review programmed schedules at any time.

8. If ON OFF times display, the keypad then displays DELETE KEEP. Press the Select key under DELETE to enter new times.
9. The keypad then displays ON TIME?. This is followed by the display - : AM PM.
Enter a new relay ON time and Select AM or PM.
The display changes to OFF TIME?. This is followed by the display - : AM PM.
Enter a new OFF time for the relay.
Enter all schedule times using a 12 hour clock. For example, to enter 6 AM you would enter 0 + 6 + 0 + 0 and press the Select key under AM. For 11 PM you would enter 1 + 1 + 0 + 0 and press the Select key under PM.
10. The keypad returns to the day of the week display allowing you to enter another Output or Door schedule. To exit the user menu or to go back to the S1 S2 S3 S4 display, press the Back Arrow key.

Setting Holiday ABC Schedules for S1, S2, S3, S4, OUT, and DOOR Schedules

Three Holiday schedules are available for each shift (S1, S2, S3, S4), each output relay (OUT), each door access relay (DOOR), and through their respective menu options. This allows a shift, output, or door to have three different schedules for holidays. For example, Holiday Schedule A for those holidays when the building stays closed, Holiday Schedule B for a day that only opens for a morning, etc. Also, Holiday Schedules can be used to cross multiple days. These schedules become active and supersede the current day's schedule when a Holiday Date occurs. See Setting Holiday Dates (HOL).

1. After you have accessed the SCHEDULES? menu and the schedule options, S1 S2 S3 S4, display, press the COMMAND key until the display changes to SUN MON TUE WED. Press the COMMAND key again to display THU FRI SAT HOL.
2. Press the Select key under HOL.
3. The keypad displays HOL: A B C . Press the Select key under A to set the first of three holiday schedules.
4. The keypad displays A - : AM PM.

Note: After Selecting the schedule, the keypad displays any current times previously set for that holiday. This feature allows you to review the programmed times.

5. If times display, the keypad then displays DELETE KEEP. Press the Select key under DELETE to enter new times.
6. The keypad then displays ON TIME? or OPENING TIME?. This is followed by the display - : AM PM.
Enter a new time and select AM or PM.
The display changes to OFF TIME? or CLOSING TIME?. This is followed by the display - : AM PM.
Enter a new time.
Enter all schedule times using a 12 hour clock. For example, to enter 6 AM you would enter 0 + 6 + 0 + 0 and press the Select key under AM. For 11 PM you would enter 1 + 1 + 0 + 0 and press the Select key under PM.
7. The keypad returns to HOL: A B C allowing you to enter a B and/or C holiday schedule for the same Shift (S1, S2, S3, or S4), Output or Door. Go back to step 3 to add additional holiday schedules.

Setting Holiday Dates (HOL)

Setting Holiday Dates provides the system with dates in the year when the normal opening and closing schedules are not used and superseded by one of the Holiday Schedules A or B or C. When the panel determines that it is a holiday, the Holiday Schedule supersedes the current schedule for that day. Up to twenty different holiday dates can be entered.

1. After you access the SCHEDULES? menu and the schedule options, S1 S2 S3 S4, display, press the COMMAND key once more. The display changes to OUT DOOR HOL EXT. Press the Select key under HOL to program Holiday dates.
2. The keypad display changes to HOL: xx mm/dd A. You can now enter the month and day for the first holiday. Press the Select key under A to change to HOL B. Pressing again changes to HOL C. Example: July fourth would be entered by pressing the 0704 keys. The keypad displays HOL:1 07/04 B.
3. To step to the next holiday number, press COMMAND. To clear a holiday press any top row key when the appropriate holiday number displays. Press the Back Arrow key when HOL: 1 or the COMMAND key when HOL: 20 displays to exit the menu.

Note: The Holiday Dates entered indicate the days of the year when HOL schedules are used. For information on setting holiday schedules for Shift, Output, and Door, see Setting Holiday ABC Schedules.

Extending Schedules (EXT)

Extending schedules (EXT) allows the Closing Check operation to delay until the new closing time expires. This allows the current shift schedule to ignore its closing time and not send a LATE TO CLOSE message to the central station. This function is designed to allow workers to stay later and does not extend door access authority. The extended schedule erases when it expires.

1. After you access the SCHEDULES? menu and the schedule options, S1 S2 S3 S4, displays, press the COMMAND key once more. The display changes to OUT DOOR HOL EXT. Press the Select key under EXT to program Extended Schedules.
2. The keypad displays - : AM PM. Enter a time to extend the current Closing Check open period. Press COMMAND to exit the menu.

A shift may be extended up to 23 hours and 59 minutes from the time the extend function is performed.

To extend the system schedule after the closing time is reached:

1. Press any Select key. The keypad will display ENTER CODE.
2. Enter your code and press COMMAND. The system schedule automatically extends one hour.
3. The keypad then displays -: AM PM. You can enter a time to extend the schedule for greater than one hour. Press AM or PM.

Note: If the system is not armed by the scheduled closing time, a Late to Close report is sent to the central station. If the schedule is extended, a Schedule Change report is sent to the central station.

Setting the Date and Time

Allows you to change the current date and time displayed on the Security Command keypad and used by the system.

Setting the System's Date and Time

1. Access the User Menu.
2. Press COMMAND until TIME? displays. Press any Select key.
3. The keypad displays the current day and time. Press the COMMAND key. The keypad displays the current date. Press the COMMAND key to make any changes.
4. The keypad displays TIME DAY DATE.
5. Press the Select key under TIME to change the time. The keypad displays - : AM PM. Enter the current time and select AM or PM. The display changes back to TIME DAY DATE.
6. Press the Select key under DAY to change the day of week. The keypad displays SUN MON TUE WED. Press the COMMAND key to display THU FRI SAT. Press the Select key under the correct day. Use the Back Arrow key to toggle between the different day of the week displays.
7. Press the Select key under DATE to change the date. The keypad displays

MONTH:- Enter up to 2 digits for the month. Press COMMAND.

DAY:- Enter up to 2 digits for the day. Press COMMAND.

YEAR:- Enter up to 2 digits for the year. Press COMMAND.

The display returns to the TIME DAY DATE display.

Press the Back Arrow key to exit the User Menu.

Display Events

Allows you to review up to 12,000 past door access and system events. There are six event types:

Zone Activity - Zone alarms, troubles, and restorals.

Opening and Closing - System arming and disarming.

User Code - Adding, deleting, and changing user codes.

Schedule Changes - Adding, deleting, and changing schedules.

Door Access - Each door access function used at a keypad.

Supervisory - Problems with system hardware components.

The system memory holds a maximum of 12,000 past events for 45 days. Any event older than 45 days automatically clears from the system memory. Also, once the full 12,000 events are stored, any new event causes the oldest event to be cleared. See Appendix A for Display Events.

Using the Display Events

1. Access the User Menu.
2. Press the COMMAND key until DISPLAY EVENTS? displays. Press any Select key.
3. The keypad displays FRST LST PRT SRT. Select FRST (first) to view the oldest to newest events. Select LST (last) to view the newest to oldest events. If you select FIRST, use the COMMAND key to scroll up through the events. If you select LAST, use the Back Arrow key to scroll down through the events.
Select SRT to sort through the Display Events log and collect information specific to a user or system event.
Select PRT to print the complete Display Events log.
4. To use the Sort feature, press the Select key under SRT. The keypad displays FRST DATE: 8/21. Press any Select key and enter a 4-digit beginning date for the sort. Press COMMAND.
5. The keypad displays LAST DATE: 10/17. Press any Select key and enter a 4-digit ending date for the sort. Press COMMAND.
6. The keypad displays USER NUMBER: -. To sort events for a particular user, enter their user number or press COMMAND to sort for all users. To search for a user, press any Select key then use the COMMAND and Back Arrow keys to browse through the user names in the system. When the user you want displays, press any Select key then press COMMAND.

7. The keypad next displays five event types that you can include in the sort. Press the fourth Select key to display YES as the event type name displays on the keypad. Press COMMAND. The following are the five sort event types:
ACCESSES = door accesses granted.
DOOR NUMBER = leave blank for all doors.

Note: If you select yes for access then only Door Access Granted Events are included in the sort.

ZONE EVENTS = zone alarms, troubles, and restorals.

ARM/DISARM = arming and disarming events.

USER EVENTS = adding, deleting, and changing user codes.

SUPERVISORY = system hardware problems and door access denied events.

8. After the last event type displays, the keypad again displays FRST LST PRT SRT. You can now view or print the sorted Display Events or press SRT to define a new sort.

Service Request

Your user code profile may be programmed for Service Request. This User Menu feature allows you to simply press any top row Select key when SERVICE REQUEST? displays and have the system automatically send a "Request for Service" message to the central station. The display changes momentarily to REQUEST MADE to confirm your request was sent.

Fire Drill

Fire Drill is used to test the fire bells or fire horns in your system. The Fire Drill test turns your system bell circuit on, but does not send a message to the central station.

Starting a Fire Drill test

1. Access the User Menu.
2. Press COMMAND until FIRE DRILL? displays. Press any Select key.
3. The keypad displays SURE? YES NO.
4. Press the Select key under YES to start the Fire Drill test.

Ending a Fire Drill test

1. Enter your code at the keypad and press COMMAND to end the Fire Drill.
2. The Fire Drill test automatically ends with ALARM SILENCE or the programmed Bell Cutoff time.

System Setup

System Setup Record

We have provided this System Setup section to allow you to track the current and future status of the programmable options on your Security Command system. If you make changes to the system, you should update the information contained on these pages.

Your system is monitored by a central station.

Yes No

C/S Name: _____

Address: _____

City/State: _____

Emergency Phone: _____

Service Phone: _____

Service Manager: _____

Your system sends Opening and Closing reports.

Yes No

Your system sends Zone Bypass reports.

Yes No

Your system sends Ambush reports.

Yes No

Security Command Keypad Record

| <u>Device #</u> | <u>Name</u> | <u>Areas</u> |
|-----------------|-------------|--------------|
| 1_____ | _____ | _____ |
| 2_____ | _____ | _____ |
| 3_____ | _____ | _____ |
| 4_____ | _____ | _____ |
| 5_____ | _____ | _____ |
| 6_____ | _____ | _____ |
| 7_____ | _____ | _____ |
| 8_____ | _____ | _____ |
| 9_____ | _____ | _____ |
| 10_____ | _____ | _____ |
| 11_____ | _____ | _____ |
| 12_____ | _____ | _____ |
| 13_____ | _____ | _____ |
| 14_____ | _____ | _____ |
| 15_____ | _____ | _____ |
| 16_____ | _____ | _____ |

Which keypads display System Status?

- 1 2 3 4
 5 6 7 8
 9 10 11 12
 13 14 15 16 N/A

Which keypads display Armed Status?

- 1 2 3 4
 5 6 7 8
 9 10 11 12
 13 14 15 16 N/A

Which keypads provide Door Access reports?

- 1 2 3 4
 5 6 7 8
 9 10 11 12
 13 14 15 16 N/A

Area Names and Numbers Record

Your system may be divided into 32 separate areas, each area can have a name or description that displays at the keypad. This can help you easily track events when and wherever they occur in your system.

Area Name

| | |
|----|-------|
| 1 | _____ |
| 2 | _____ |
| 3 | _____ |
| 4 | _____ |
| 5 | _____ |
| 6 | _____ |
| 7 | _____ |
| 8 | _____ |
| 9 | _____ |
| 10 | _____ |
| 11 | _____ |
| 12 | _____ |
| 13 | _____ |
| 14 | _____ |
| 15 | _____ |
| 16 | _____ |

Area Name

| | |
|----|-------|
| 17 | _____ |
| 18 | _____ |
| 19 | _____ |
| 20 | _____ |
| 21 | _____ |
| 22 | _____ |
| 23 | _____ |
| 24 | _____ |
| 25 | _____ |
| 26 | _____ |
| 27 | _____ |
| 28 | _____ |
| 29 | _____ |
| 30 | _____ |
| 31 | _____ |
| 32 | _____ |

User Profiles Record

| Profile # | Profile Name | Arm/Disarm Area | Access Area | Output Group | Arm/Disarm | Alarm Silence | Sensor Reset | Door Access | Armed Area | Outputs On/Off | Zone Status | Bypass Zones | Zone Monitor | System Status | System Test | User Profiles | User Codes | Schedules | Time | Display Events | Service Request | Fire Drill | Extend Schedules | Temp User Code | Anti-passback | Shift/Time Access | |
|-----------|--------------|-----------------|-------------|--------------|------------|---------------|--------------|-------------|------------|----------------|-------------|--------------|--------------|---------------|-------------|---------------|------------|-----------|------|----------------|-----------------|------------|------------------|----------------|---------------|-------------------|-----------|
| | | | | | | | | | | | | | | | | | | | | | | | | | | 1 2 3 4 A | |
| | | | | | | | | | | | | | | | | | | | | | | | | | | | 1 2 3 4 A |
| | | | | | | | | | | | | | | | | | | | | | | | | | | | 1 2 3 4 A |
| | | | | | | | | | | | | | | | | | | | | | | | | | | | 1 2 3 4 A |
| | | | | | | | | | | | | | | | | | | | | | | | | | | | 1 2 3 4 A |
| | | | | | | | | | | | | | | | | | | | | | | | | | | | 1 2 3 4 A |
| | | | | | | | | | | | | | | | | | | | | | | | | | | | 1 2 3 4 A |
| | | | | | | | | | | | | | | | | | | | | | | | | | | | 1 2 3 4 A |
| | | | | | | | | | | | | | | | | | | | | | | | | | | | 1 2 3 4 A |
| | | | | | | | | | | | | | | | | | | | | | | | | | | | 1 2 3 4 A |
| | | | | | | | | | | | | | | | | | | | | | | | | | | | 1 2 3 4 A |
| | | | | | | | | | | | | | | | | | | | | | | | | | | | 1 2 3 4 A |
| | | | | | | | | | | | | | | | | | | | | | | | | | | | 1 2 3 4 A |
| | | | | | | | | | | | | | | | | | | | | | | | | | | | 1 2 3 4 A |
| | | | | | | | | | | | | | | | | | | | | | | | | | | | 1 2 3 4 A |
| | | | | | | | | | | | | | | | | | | | | | | | | | | | 1 2 3 4 A |
| | | | | | | | | | | | | | | | | | | | | | | | | | | | 1 2 3 4 A |
| | | | | | | | | | | | | | | | | | | | | | | | | | | | 1 2 3 4 A |
| | | | | | | | | | | | | | | | | | | | | | | | | | | | 1 2 3 4 A |

Schedules Record

| Schedule | Area Name | Status | SUN | MON | TUE | WED | THU | FRI | SAT | HOL A | HOL B | HOL C |
|-----------------------|-----------|--------|-----|-----|-----|-----|-----|-----|-----|-------|-------|-------|
| S1 S2 S3 S4 Area # | | Open | :_M | :_M | :_M | :_M | :_M | :_M | :_M | :_M | :_M | :_M |
| | | Close | :_M | :_M | :_M | :_M | :_M | :_M | :_M | :_M | :_M | :_M |
| S1 S2 S3 S4 Area # | | Open | :_M | :_M | :_M | :_M | :_M | :_M | :_M | :_M | :_M | :_M |
| | | Close | :_M | :_M | :_M | :_M | :_M | :_M | :_M | :_M | :_M | :_M |
| S1 S2 S3 S4 Area # | | Open | :_M | :_M | :_M | :_M | :_M | :_M | :_M | :_M | :_M | :_M |
| | | Close | :_M | :_M | :_M | :_M | :_M | :_M | :_M | :_M | :_M | :_M |
| S1 S2 S3 S4 Area # | | Open | :_M | :_M | :_M | :_M | :_M | :_M | :_M | :_M | :_M | :_M |
| | | Close | :_M | :_M | :_M | :_M | :_M | :_M | :_M | :_M | :_M | :_M |
| S1 S2 S3 S4 Area # | | Open | :_M | :_M | :_M | :_M | :_M | :_M | :_M | :_M | :_M | :_M |
| | | Close | :_M | :_M | :_M | :_M | :_M | :_M | :_M | :_M | :_M | :_M |
| S1 S2 S3 S4 Area # | | Open | :_M | :_M | :_M | :_M | :_M | :_M | :_M | :_M | :_M | :_M |
| | | Close | :_M | :_M | :_M | :_M | :_M | :_M | :_M | :_M | :_M | :_M |
| S1 S2 S3 S4 Area # | | Open | :_M | :_M | :_M | :_M | :_M | :_M | :_M | :_M | :_M | :_M |
| | | Close | :_M | :_M | :_M | :_M | :_M | :_M | :_M | :_M | :_M | :_M |
| S1 S2 S3 S4 Area # | | Open | :_M | :_M | :_M | :_M | :_M | :_M | :_M | :_M | :_M | :_M |
| | | Close | :_M | :_M | :_M | :_M | :_M | :_M | :_M | :_M | :_M | :_M |
| Door# Output # | | Open | :_M | :_M | :_M | :_M | :_M | :_M | :_M | :_M | :_M | :_M |
| | | Close | :_M | :_M | :_M | :_M | :_M | :_M | :_M | :_M | :_M | :_M |
| Door# Output # | | Open | :_M | :_M | :_M | :_M | :_M | :_M | :_M | :_M | :_M | :_M |
| | | Close | :_M | :_M | :_M | :_M | :_M | :_M | :_M | :_M | :_M | :_M |
| Door# Output # | | Open | :_M | :_M | :_M | :_M | :_M | :_M | :_M | :_M | :_M | :_M |
| | | Close | :_M | :_M | :_M | :_M | :_M | :_M | :_M | :_M | :_M | :_M |
| Door# Output # | | Open | :_M | :_M | :_M | :_M | :_M | :_M | :_M | :_M | :_M | :_M |
| | | Close | :_M | :_M | :_M | :_M | :_M | :_M | :_M | :_M | :_M | :_M |

Holiday Date Record

Your system has up to 20 holiday dates available that supersede all regular scheduled times for that day.

| # | Date (mm/dd) | HOL (circle one) |
|-----|--------------|------------------|
| 1. | ____/____ | A or B or C |
| 2. | ____/____ | A or B or C |
| 3. | ____/____ | A or B or C |
| 4. | ____/____ | A or B or C |
| 5. | ____/____ | A or B or C |
| 6. | ____/____ | A or B or C |
| 7. | ____/____ | A or B or C |
| 8. | ____/____ | A or B or C |
| 9. | ____/____ | A or B or C |
| 10. | ____/____ | A or B or C |
| 11. | ____/____ | A or B or C |
| 12. | ____/____ | A or B or C |
| 13. | ____/____ | A or B or C |
| 14. | ____/____ | A or B or C |
| 15. | ____/____ | A or B or C |
| 16. | ____/____ | A or B or C |
| 17. | ____/____ | A or B or C |
| 18. | ____/____ | A or B or C |
| 19. | ____/____ | A or B or C |
| 20. | ____/____ | A or B or C |

System Setup

Output Relay Record

Your system has ____ output relays that are used to control various functions within the building or access around its perimeter. Below is a list of the devices they control.

| Output # | Output Name |
|----------|-------------|
| _____ | _____ |
| _____ | _____ |
| _____ | _____ |
| _____ | _____ |
| _____ | _____ |
| _____ | _____ |
| _____ | _____ |
| _____ | _____ |
| _____ | _____ |
| _____ | _____ |
| _____ | _____ |
| _____ | _____ |
| _____ | _____ |
| _____ | _____ |
| _____ | _____ |
| _____ | _____ |
| _____ | _____ |
| _____ | _____ |
| _____ | _____ |
| _____ | _____ |
| _____ | _____ |
| _____ | _____ |

Use the Output number in the User Menu when setting Output Schedules or using the Outputs ON OFF option to manually toggle the relays.

XR500 User's Guide

Appendix A

About the Display Events Section

This section of the User's Guide shows the Display Events items for 32-character keypad displays. While in the Display Events function, use the COMMAND and Back Arrow keys to go forward or backward through the list of events.

To view more information about each display, press the Select key as directed in the explanations below.

Arming and Disarming Event Displays

This displays any system area arming or disarming events.

32-Character Display

```
ARM  5:10P  10/ 17
WAREHOUSE
```

Description

The area was armed at 5:10 PM. Press any Select key to display the area number and user number, and then any Select key to display the user name.

Arming Event Types - There are two event types you may see here:

- ARM** - User armed the system
- DIS** - User disarmed the system

Zone Event Displays

This displays alarms, troubles, and other events that may occur on your protection zones.

32-Character Display

```
ALR  10:23P  10/17
BASEMENT DOOR
```

Description

An alarm occurred at 10:23 PM on Oct. 17. Press any Select key to see the zone number and zone type.

Zone Type - There are seven possible zone types you may see here.

- FIRE** - Fire
- PANC** - Panic
- BURG** - Burglary
- EMRG** - Emergency
- SUPV** - Supervisory
- AUX1** - Auxiliary 1
- AUX2** - Auxiliary 2

Event Types - There are seven event type you may see here:

- ALR** - Alarm
- TBL** - Trouble
- RST** - Restore
- LOW** - Low battery
- MIS** - Missing wireless transmitter
- FLT** - Zone Fault
- SVC** - Service smoke detector

Note: LOW and MIS are for wireless systems only.

User Code Change Event Displays

This displays any addition, deletion, or change to a user code.

32-Character Display

```
ADD  11:41A 10/ 17
U:19  BY    U:12
```

Description

User 19 added by user 12 at 11:41 AM. Press the Select key under either user (US:) number for the user name.

User Code Event Types - There are three event type you may see here:

ADD - User added

DEL - User deleted

CHG - User code or authority level changed.

Supervisory Event Displays

This displays the date and time of an automatic test report.

32-Character Display

```
MSG  11:58P 10/ 17
AUTO RECALL
```

Description

The test report was sent to the central station at the date and time shown.

System Monitor Event Displays

This displays any problems with the system AC power, battery, or phone line(s), or any opening of a tampered panel box.

32-Character Display

```
TBL  11:41A 10/ 17
POWER
```

Description

An AC failure occurred at 11:41 AM. on Oct. 17.

System Monitor Event Types - There are 2 event types:

TBL - Trouble

RST - Restore

System Monitor Event Names - There are 5 system monitors:

POWER - AC power to panel

BATTERY - On panel

LINE 1 - Phone line number 1

LINE 2 - Phone line number 2

TAMPER - On panel box

Door Access Event Displays

This displays the keypad address where a Door Access occurred and the user number of the person granted access.

32-Character Display

| | | |
|-----|----------|--------|
| ACC | 5:18P | 10/ 17 |
| 3 | USER:024 | |

Description

Door (keypad) #3 was accessed by user 24 at 5:18 PM on Oct. 17. Press the first Select key to display the Door name where the access occurred. Press the second Select key to display the reason access was denied. Press the third Select key for the name of the device, or the fourth key for the user name.

About Door Access

Door Access is a feature available on certain Security Command keypads that contain a built-in door releasing relay and proximity readers. When power for an electric door strike or magnetic lock is connected to the relay contacts, only users entering a valid user code can release the lock and gain access to the area.

The Display Events feature logs the user number and name of the person granted access, the date and time, and from which keypad they entered their code.

Schedule Change Event Displays

This displays Changes made to the system schedules.

32-Character Display

| | | |
|-----|----------|--------|
| S1 | 9:41A | 10/ 17 |
| MON | USER:024 | |

Description

S1 schedule for Monday was changed by user 24 at 9:41 AM on Oct. 17.

Schedule Types - There are five possible schedule types:

S1 S2 S3 S4 - Standard

OUT - Output

DOOR - Door

HOL - Holiday

EXT - Extend

MON - This is the day of the week in which the schedule change occurred. The days display using three letters. Press the first Select key to display the scheduled Opening time and once again for the scheduled Closing time.

024 - User number of the person who made the change. Press the third Select key (the Select key under 024) to display the user name.

Zone Bypass Event Displays

This displays zone bypass events.

32-Character Display

| |
|---------------------------------|
| BYP 5:18P 10/ 17 EAST WINDOW |
|---------------------------------|

Description

The east window zone was bypassed. Press a Select key for the zone number and user number. Press again for the user name.

Bypass Event Types - There are three event types:

BYP - Bypass

RST - Restore

FRC - Force Arm

Note: You may sometimes see the user as SWG. This is short for Swinger Bypass which is an automatic function that allows the system to automatically bypass a zone.

Appendix B

Zone Status Browser

Access the User Menu. Press COMMAND until ZONE STATUS appears.

ZONE STATUS?
[] [] [] []

Press any SELECT key then press the SELECT key under NBR.

ARM BYPS ALR NBR
[] [] [] []

Press one of the left two SELECT keys to browse through the names of zones.

ZONE NO: -
[] [] [] []

SELECT AREA
[] [] [] []

This prompt allows you to search for a zone by area. Press the COMMAND key to scroll through the list of areas.

FRONT OFFICE
[] [] [] []

When the area where the zone is located is displayed, press any SELECT key.

24 HOUR ZONES
[] [] [] []

After all the areas are displayed, the system allows you to search through the 24 hour zones (Fire, Panic, Supervisory, etc.).

SELECT ZONE
[] [] [] []

Press the COMMAND key to scroll through the list of all zone names.

SELECT ZONE
[] [] [] []

When the correct zone name is displayed, press any SELECT key.

EAST DOOR
[] [] [] []

HALL SMOKE
[] [] [] []

When the correct zone name is displayed, press any SELECT key.

Verify the zone number matches the previously shown name.

ZONE NO: 0 1 2
[] [] [] []

ZONE NO: 0 3 4
[] [] [] []

Verify the zone number matches the previously shown name.

Press COMMAND.
[] [] [] []

Press COMMAND.
[] [] [] []

The system displays one of these zone status messages:
-OKAY = the zone is normal
-BYPAS = the zone is bypassed
-BAD O = the zone is open
-BAD S = the zone is shorted

EAST DOOR - OKAY
[] [] [] []

HALL SMOKE - OKAY
[] [] [] []

The system displays one of these zone status messages:
-OKAY = the zone is normal
-BYPAS = the zone is bypassed
-BAD O = the zone is open
-BAD S = the zone is shorted

Pressing COMMAND allows you to enter another zone number.

Bypass Zones Browser

Access the User Menu. Press COMMAND until BYPASS ZONES appears. Press any SELECT key.

BYPASS ZONES?
[] [] [] []

Press either of the two left SELECT keys.

ZONE: - RST BYP
[] [] [] []

This prompt allows you to search for a zone by area. Press the COMMAND key to scroll through the list of areas.

SELECT AREA
[] [] [] []

When the area where the zone is located is displayed, press any SELECT key.

FRONT OFFICE
[] [] [] []

Press the COMMAND key to scroll through the list of all zone names.

SELECT ZONE
[] [] [] []

When the correct zone name is displayed, press any SELECT key.

EAST DOOR
[] [] [] []

The display shows the zone number. Press the SELECT key under RST to Reset the zone. Press the SELECT key under BYP to Bypass the zone.

ZONE:012 RST BYP
[] [] [] []

The display returns to the ZONE: prompt allowing you to enter another zone number.

ZONE: - RST BYP
[] [] [] []

Zone Monitor Browser

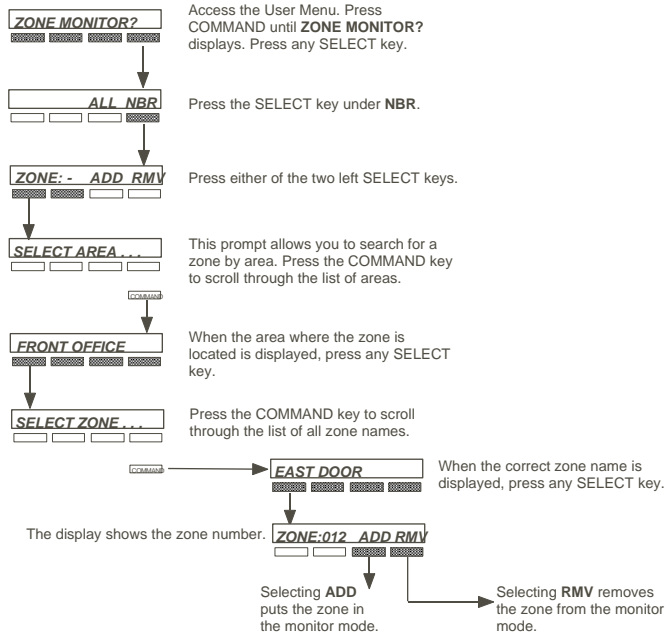

Add User Codes Browser

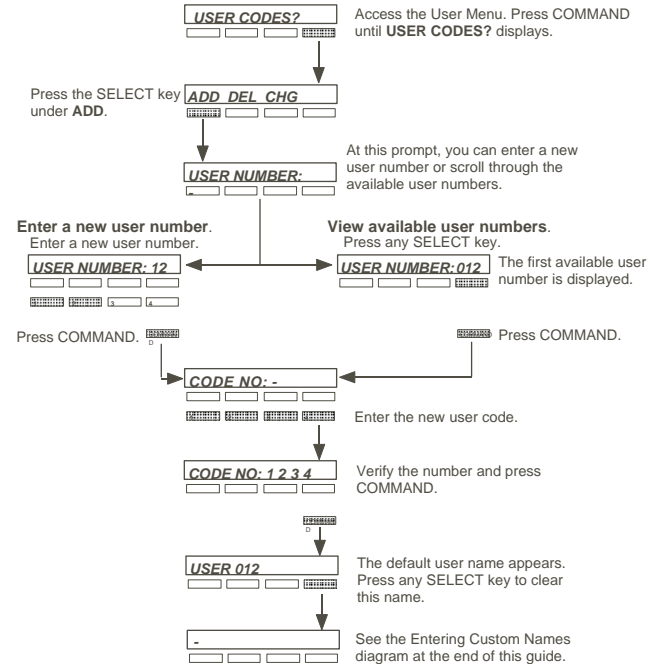

Delete User Codes Browser

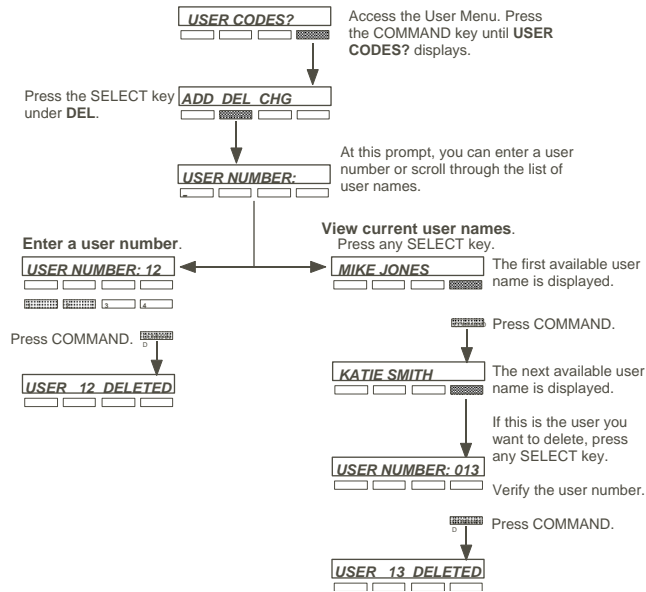

Change User Codes Browser

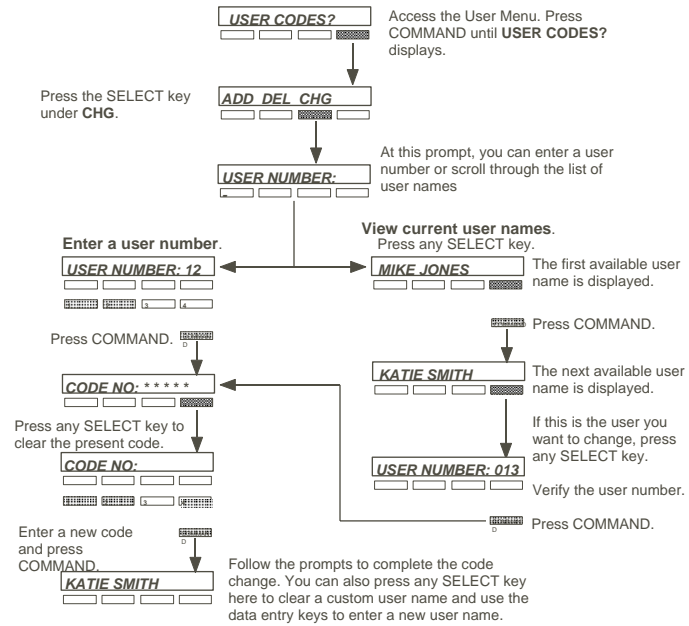

Entering User Names

1
To enter a custom name into the keypad, you'll be using the 3 rows of number keys.

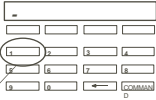

Once you've cleared the default name, the display shows just a dash on the left side.

2
Under each number key are three letters. To enter a custom name, press the number key above the letter you want to enter.

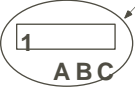

3
With the number displayed, press the SELECT key that matches the position of the letter. See example.

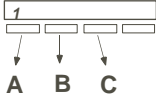

4
Once the letter you want is displayed, press the number key above the next letter you want to enter.



You can enter up to 16 characters for each name into the keypad.

The nine and zero keys . . .

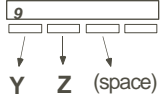

Pressing the **9** key provides you with Y, Z, and a space that you can use between names. For example: B O B S M I T H.

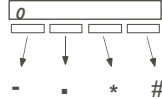

Pressing the **0** (zero) key provides you with a (dash), (period), (asterisk), and a (pound sign).

Appendix C

Easy Entry™ User's Guide

DOOR STRIKE

From the Status List, present your card to the reader. Once validated by the system, the Door Strike relay activates. If you are entering an armed area to which you are assigned, accessing the area automatically causes it to be disarmed.

While the keypad is in the Status List, present your access card. The relay activates momentarily during which you must open the door. Once you open the door, you have 30 seconds to exit and close the door before the zone 2 Soft-Shunt expires and triggers an alarm.

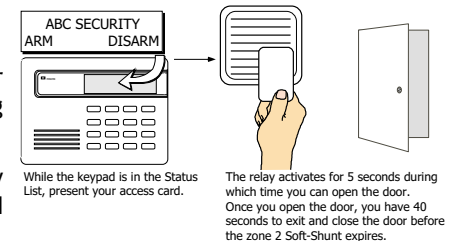

ARMING AND DISARMING AN AREA SYSTEM

Press Command. The keypad displays **ARM DISARM**. Press the Select key under either option. The keypad displays **ENTER CODE-**. Present your card to the reader. Once validated by the system, all areas accessible by you arm or disarm automatically. Select **NO** to arm or disarm individual areas. Select **YES**, or simply wait, and the keypad automatically arms or disarms all areas for which you are authorized.

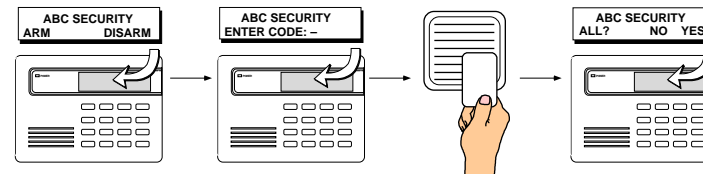

DISARMING WITH ENTRY DELAY

Once the protected door is opened and the entry delay starts, the keypad displays **ENTER CODE: -**. Present your card to the reader. Once validated, the system disarms all areas accessible by you. Area systems provide a delay to allow you to disarm selected areas only. See Arming and Disarming above.

Using the access reader for user menu access

You can also use a card reader to access the User Menu. When the **MENU? NO YES** displays, enter a code when requested.

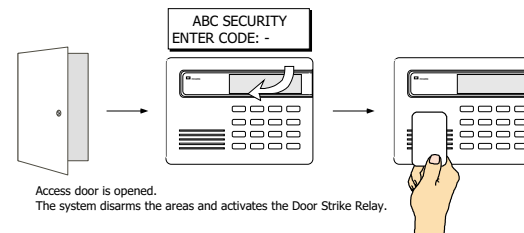

Frequently asked questions

This section attempts to answer questions you might have regarding Security Command system operation.

Q. If I bypass an exit delay door when I arm the system, will I get an alarm if I come through it later?

A. You will not get an alarm from the door because it is bypassed, but if you happen to walk through a motion detector space or other armed door inside the premises an alarm activates.

Q. When I arm or disarm my Area system, **ALL? NO YES** displays. Does this mean all areas in the system?

A. Choosing **YES** arms or disarms all areas that are authorized for your user code.

Q. How do I create a schedule that starts at 8:00 AM on Monday and ends at 5:00 PM on Friday.

A. In the days of the week display, select **MON** (Monday). For the **OPENING TIME?**, enter 0 + 8 + 0 + 0 AM. For the **CLOSING TIME?**, at the **MON – : AM PM** display press the Select key under **MON**; this scrolls through the days of the week. Stop at the day you want the schedule to end. Next, enter 0 + 5 + 0 + 0 PM into the **FRI – : AM PM** closing time display. Press **COMMAND**. Press the Back Arrow key to exit the User Menu.

This sets the opening time to 8:00 AM Monday and the closing time to 5:00 PM Friday. You can substitute any other day or time in this example.

Q. What do I do if I want to be in the building past the scheduled closing (arming) time?

A. If your system is programmed for closing check, the keypad emits a steady tone prior to the system arming. During this tone, press any Select key to display **ENTER CODE: .** Enter your user code and press **COMMAND**.

The keypad now displays the enter time display – : **AM PM**. Enter in the new time you want the system to arm and press **COMMAND**. The time you enter may extend past midnight by pressing the **AM** key after entering the appropriate time.

Common Keypad Displays

Listed below are several keypad messages you may see on the display. Follow the instructions in the Possible Solutions column to correct the problem. In many cases, you will need to call a service person to correct the problem. Displays that are not discussed here mean that your service representative should be called.

| Message | Meaning | Possible Solutions |
|-----------------|---|---|
| Invalid Area | The user has attempted a door access for an area they are not assigned. | Change the user access areas if access to the area is needed. If access is not needed, the user cannot enter the area. |
| Invalid Code | The user code you entered is not recognized by the system. | Check the user code and try again. |
| Invalid Level | The code have used does not have the authority level required to perform the task you are attempting. | Be sure the correct level is set for the code. Remember that you can only grant a user authority if you have the same authority level or greater: You can't give what you don't have. |
| Invalid Profile | A user has attempted a function that is outside of the assigned profile. | Check the user profile settings. |
| Invalid Time | A user code assigned to a specific schedule has entered outside of the valid schedule. | See Schedules and User Codes. |
| Enter 2nd Code | The area you are attempting to disarm or access is a Two Man Area. | A second and different user code must be entered. |
| Closing Time | The scheduled has expired but the area has not been armed. | Users still on the premise should arm the system or extend the schedule to a later time. |
| Late to Close | The system was not armed at its scheduled closing time. | Users still on the premise should arm the system or extend the schedule to a later time. |
| Failed to Exit | A user assigned the anti-passback option has attempted to re-enter an area from which they did not exit properly. | The user must exit the area through the proper door. If not possible, your system administrator should select the Forgive option in the User Codes menu. |

Index

Symbols

2-Button Panic Keys 3

A

Alarm Silence 14
Ambush Codes 26
Anti-Pass Back 6
AREA LATE! 27
Area Names and Numbers Record 37
Armed Areas Display 15
Arming 9

B

Browser
 Add User Codes 47
 Bypass Zones 46
 Change User Codes 48
 Delete User Codes 48
 Entering User Names 49
 Zone Monitor 47
 Zone Status 46
Bypassing
 when arming bad loops 3
Bypass Zones 18

C

CLOSING TIME! 27
Common Keypad Displays 54

D

Date and Time 32
Disarming 11
Display Events 32, 42
 Arming and Disarming Event Displays 42
 Door Access Event Displays 44
 Schedule Change Event Displays 44
 Supervisory Event Displays 43
 System Monitor Event Displays 43
 User Code Change Event Displays 43
 Zone Bypass Event Displays 45
 Zone Event Displays 42
Door Access 15

E

Easy Entry™ User's Guide 50
Extending Schedules 31

F

Failure to Exit 26
False Alarms 1
Fire Drill 34
Forgive Failure to Exit 26
Frequently asked questions 53

H

Holiday Date
 Setting Holiday Dates 31
Holiday Date Record 41

K

Keypad
 2-Button Panic Keys 3
 Data Entry Keys 3
 Tones 5
 User Menu 1
 Wireless Displays 7

L

LED
 AC 3
 Armed 3

O

Outputs On Off 16

P

Pager Direct™ User's Guide 51
Profiles 21
 Adding 21
 Changing 23
 Deleting 23
 Name 21
 Number 21

S

Schedules 27
 Extending Schedules 7, 31
 Extend (EXT) 27
 Holiday (HOL) 27
 Output (OUT) 27
 Setting Holiday ABC Schedules 30
 Setting Output and Door Schedules 29
 Setting Shift Schedules 28
 Shift (S1, S2, S3, S4) 27
Schedules Record 40
Security Command Keypad 1, 3
Security Command Keypad Record 35
Sensor Reset 14
Service Request 34
Status List 8
System Setup Record 35
System Status 19
System Test 20

T

TEMP CODE 23

U

User Codes 24
 Adding 24
 Changing 25
 Deleting 25
 Names 24
 Profile 24
User Menu Options 13
User Profiles 21

Z

Zone Monitor 18
Zone Status 17

This page has been intentionally left blank.

